

Interactive Whiteboard

User Manual

Please retain this manual properly for future reference.

This is the general manual for Interactive Whiteboard and there might be slight differences between the actual product and the descriptions.

Table of Contents

ATTENTION	2
SYSTEM REQUIREMENTS	3
INTRODUCTION	4
HOW TO INSTALL	5
HOW TO INSTALL HARDWARE	5
HOW TO INSTALL SOFTWARE	15
CALIBRATION	16
HOW TO USE THE WHITEBOARD	19
HOW TO USE THE SMART PEN TRAY	21
SCREEN KEYS	23
TROUBLE SHOOTING	25
SPECIFICATIONS	27

Attention

- Do not expose this whiteboard to rain or moisture so as to reduce the risk of fire or electric shock.
- Do not expose this whiteboard to fire, electric shock and long time direct sunlight.
- This device is heavy with N.W. over 15 Kg. Use expansion bolts to fix the device to the wall.
- When the projector and interactive whiteboard are used together, do not stare directly at the light from the projector. Especially the kids should be warned about this.
- This user manual is only applicable to IR interactive whiteboard products.
- Only the matched pens from our company or human fingers can write or operate on the interactive whiteboard.
- This product uses the IR annotation technology. Make sure the product will not contact with any other hard objects so as to avoid deformation from squeezing.
- If the interactive whiteboard is connected with wire, make sure the connection between this device and computer is safe. You are recommended to do hidden wiring to avoid pulling and dragging the cables.
- If the interactive whiteboard is connected with wire, use the cables in the accessory box. Other cables might not be compatible with this product.
- If the interactive whiteboard is in RF connection, the distance between the wireless receiver and interactive whiteboard must $\leq 15\text{m}$ and no obstacles shielding electromagnetic waves are allowed.
- Do not touch, cut, or scratch the panel and frame with sharp or hard objects. Do not drill holes or nail in any place of the product since it might damage the device.
- For the instructions of writing software, please refer to its user manual and there will be no more instructions in this user manual.

System Requirements

Lowest Environmental Requirements:

- CPU: 1.0GHzx86
- Memory: 512M Byte
- Display Card: Support 256 or above
- Hard Disk:1GByte
- Screen Display Resolution: 800x600、1024x768、1280x1024
- USB1.1 Port

Recommended:

- CPU: 2.0GHzx86
- Memory: 2GB or above
- Display Card: Support 256 or above
- Hard Disk:2GByte
- Screen Display Resolution: 1024x768、1280x1024
- USB2.0 Port

Software Running Environment: **Microsoft Windows XP/Vista/Win7/Win8**

Introduction

This interactive whiteboard uses IR scan and sensor technology. Working seamlessly with a projector and computer, the Interactive whiteboard can become a large touch display. Any projected image in the whiteboard can be operated by pens or fingers directly. Thus, it provides an interactive presentation platform for the lecturers.

Main Performances:

- Writing: User can write and draw with pens or fingers directly on the display panel and show your writing info instantaneously during speech and lecture.
- Annotation: The user can operate and annotate over any popular format files including PPT、WORD、EXCEL、AVI、MPEG、JPEG and etc.
- Touching: In working mode, the interactive whiteboard can also be a high precision touching interactive whiteboard. User can use fingers or wand as a mouse to click and drag directly on the display panel.
- Touch Recognition: The interactive whiteboard can recognize touch of a single-finger, multi-finger, double click, left-click and right click.
- Hot Keys: Have hot keys on one side or both sides.
- Smart Pen tray: Support smart pen tray. User can change pen writing stroke colors when using this smart pen tray.
- Drive Free Mode: This product design is in accordance with HID category standard and supports drive free mode.
- Display Panel: High gain and high contrast display
- Energy Conservation: Power consumption less than 1W. No need for any independent power supply.

Note: On the upper left and bottom right corner, there are projection area line s(such as "┌、└"). When images are projected to the interactive whiteboard, projection area should be limited within these lines for better writing effects.

How to Install

The following instructions have stated the installation for all series products from our company. The user can refer to corespondent instructions according to the products purchased. Please contact the local distributor for mor details.

How to Install Hardware

I. Whiteboard installation for A series

1. Firstly install the smart pen tray of the interactive whiteboard: Insert the box underprop into the pen tray. The PCB in pen tray should be exactly in the outlet of the underprop and the pen tray joints should be exactly in the box underprop slot. Screw in two M3 screws from the bottom of the pen tray. Shown as follow:

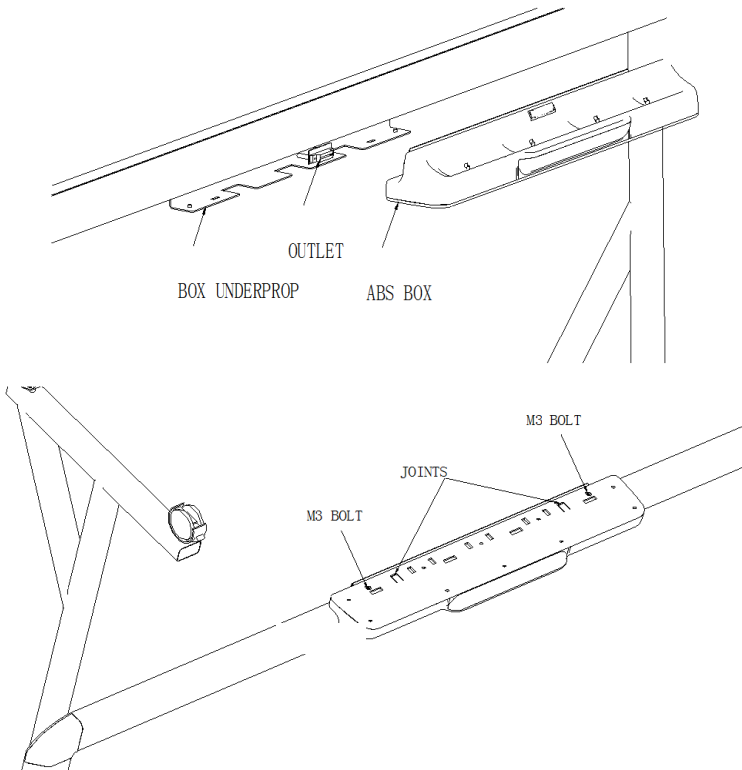

2. Drill 8 holes for expansion bolts on the wall according to your preference (shown as a). Install the wall-mount brackets and tighten bolts into each hole. Hang up the whiteboard with calibration hole D in four corners in the wall-mounting bolts (shown as b).

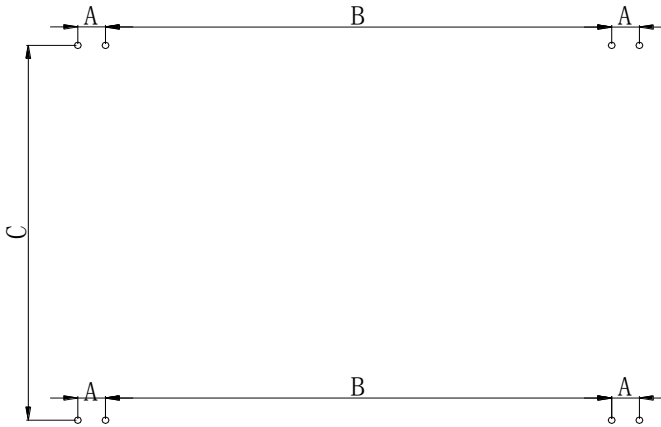

(a)

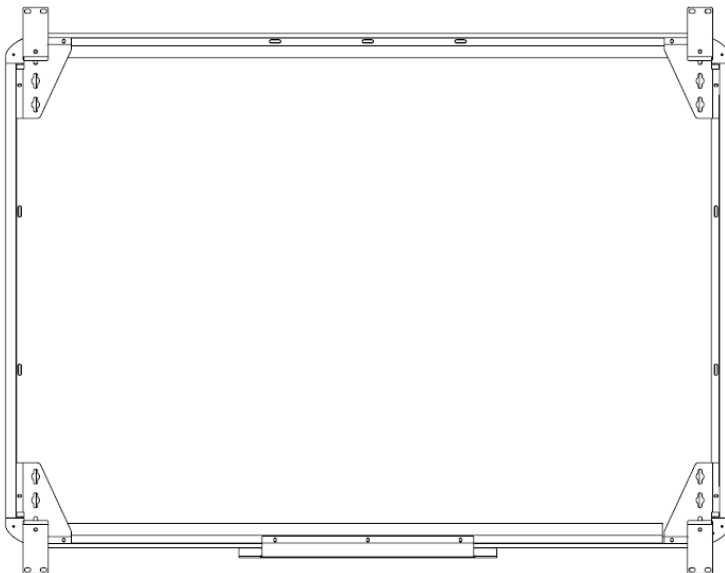

(b)

II. Whiteboard installation for B series

1. Firstly install the smart pen tray of the interactive whiteboard: Lock the smart pen tray to the metal supporting plate with three M5 bolts. Shown as follow:

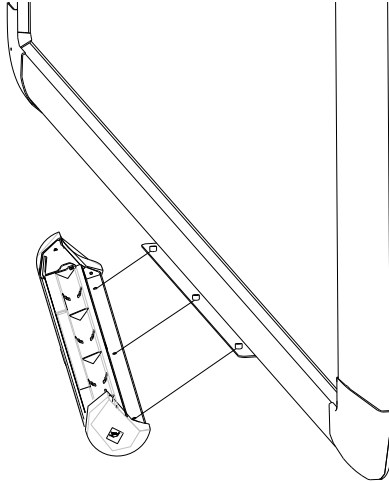

2. There are wall-mount brackets A and B on the back of the whiteboard. Wall-mount brackets B should be screwed. Shown as follow:

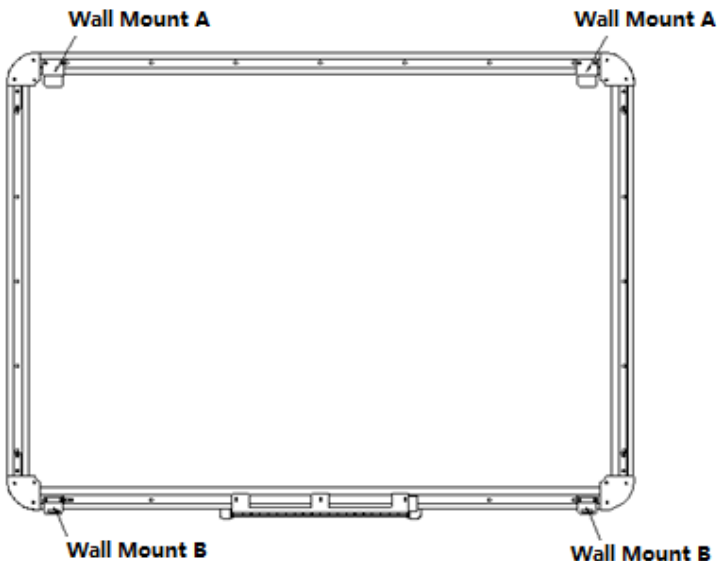

Install the fixing plate according to the space between wall-mounts brackets
A:



After hanging up the whiteboard, drill 2 holes for expansion bolts according to actual positions, and fix wall-mount brackets B into the wall. Shown as follow:

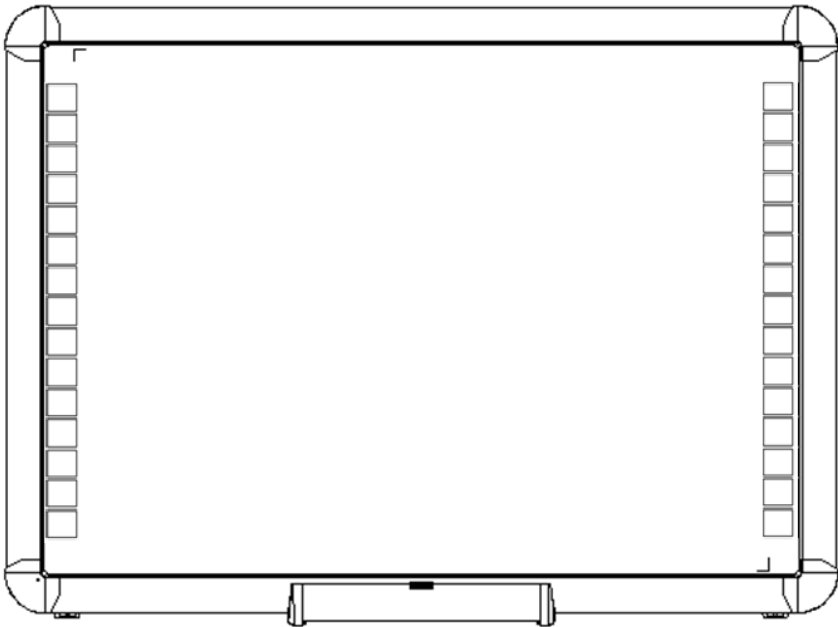

III. Whiteboard installation for C series

The whiteboards in this series have ultra-thin frames. To install with traditional blackboards, you are recommended to have embedded installation. You can contact the local distributor or our company to obtain the engineering drawings for corresponding products.

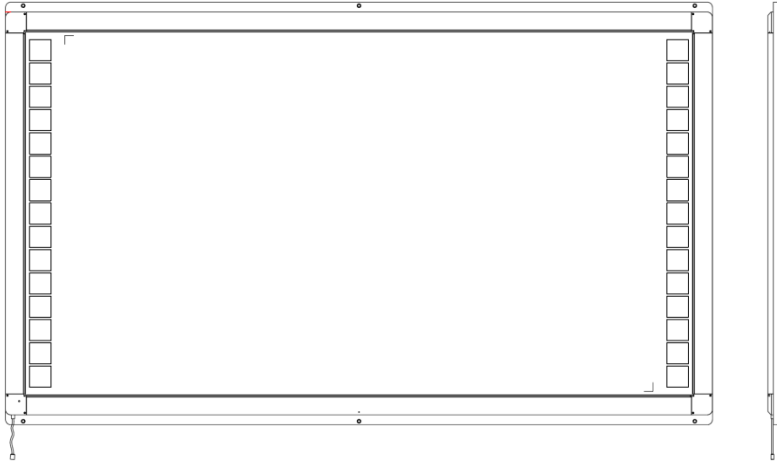

Whiteboard Diagram

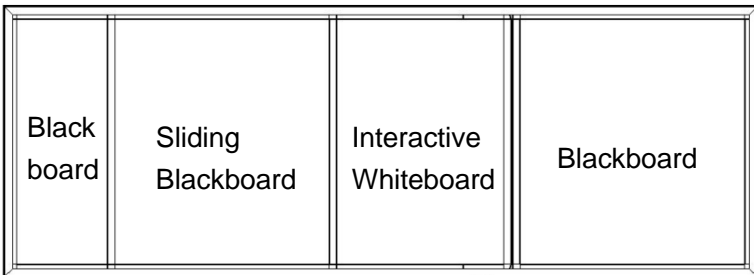
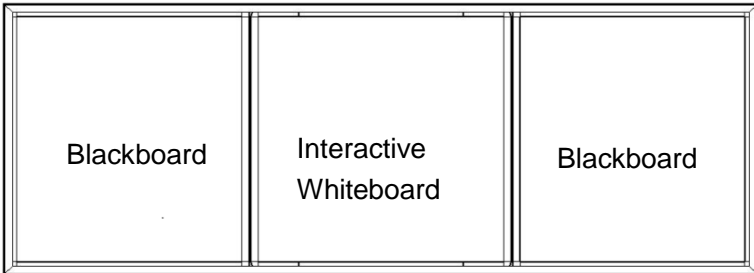

Embedded Installation Diagram

IV. Whiteboard installation for D. E&F series

1. Firstly install the smart pen tray of the interactive whiteboard: First, please insert the 4 pin pen cable into the pen box of smart pen tray. Insert the box under prop into the pen tray. The PCB in pen tray should be exactly in the outlet of the underprop and the pen tray joints should be exactly in the box underprop slot. Screw in two M3 screws from the bottom of the pen tray. Shown as follow:

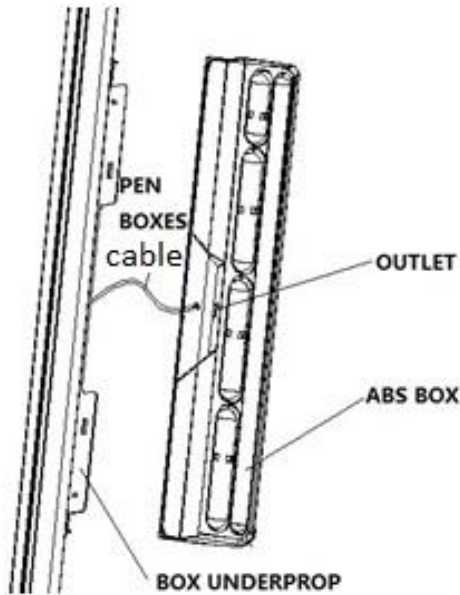

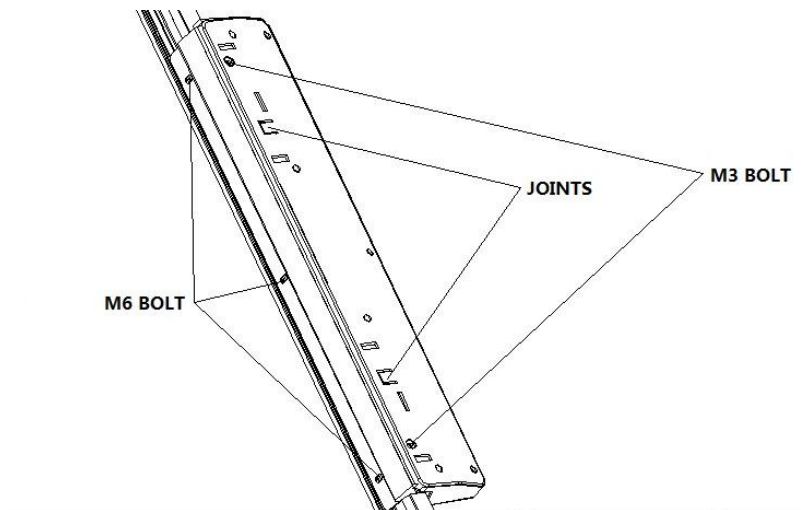

2. There are 4 pieces of whiteboard wall-mount brackets in the accessory box as follow. Place them on the wall according to the position of the hooks on the back of whiteboard and fix them with expansion bolts.

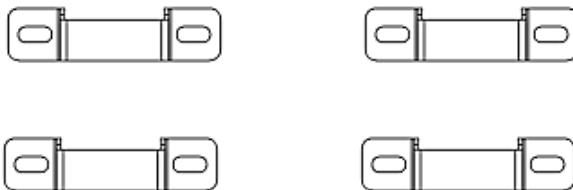

3. Hang the whiteboard onto wall-mount brackets and make sure the hooks on whiteboard catch the brackets. Shown as follow C,D,E:



(C)

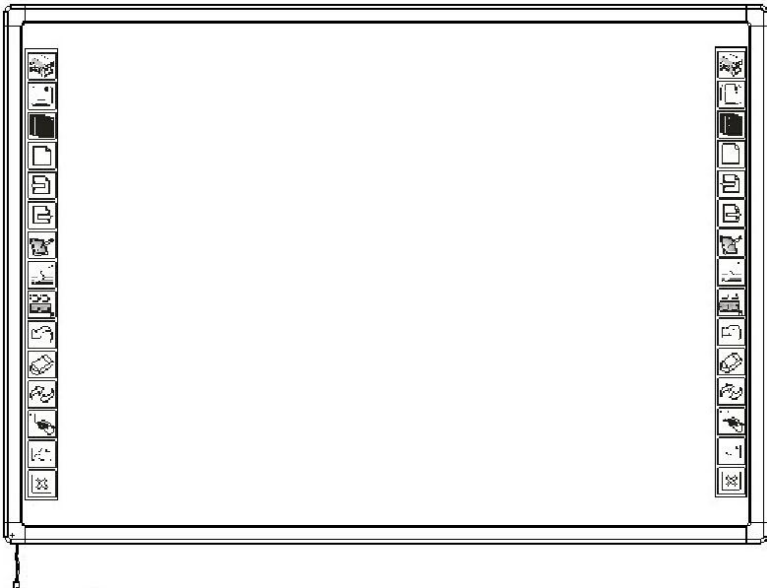

(D)

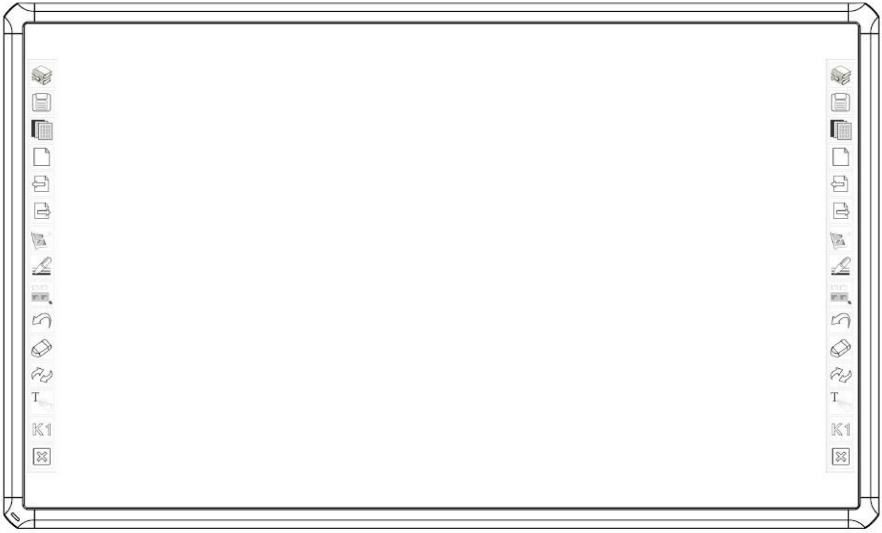

(E)

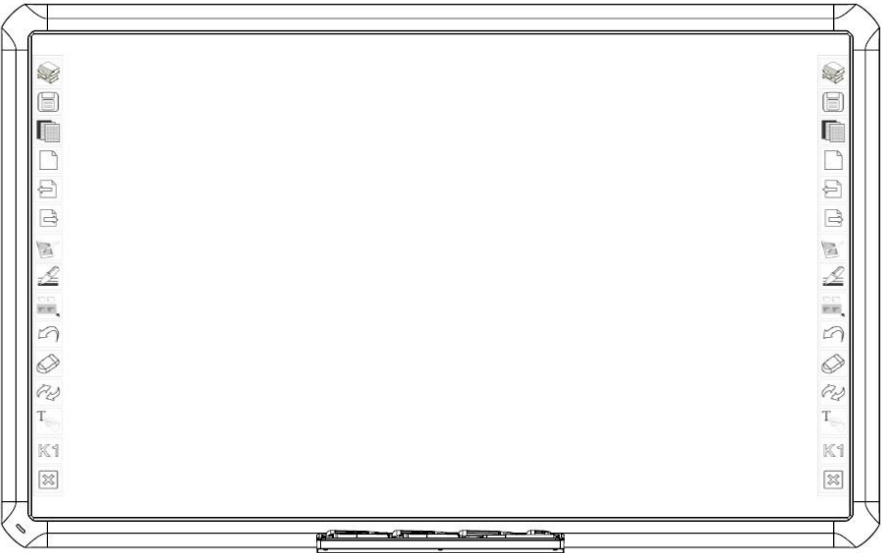

(F)

V. Interactive System Building

1. Make sure the whiteboard is firmly fixed before building the interactive system.
2. Adjust the positions of the projector and whiteboard to make sure images are projected to writing area of the whiteboard in full screen.
3. One corner of the whiteboard is set with USB port(position of USB port will be varied in different models). Plug the USB cable into the USB port. The USB cable in the accessory box is designed for this whiteboard. Normal USB cable might not be compatible to this whiteboard.
4. Connect the USB cable to the USB port in the computer.
5. Connect the computer and projector (You can refer to the projector User Manual for more details).

How to Install Software

Before software installation, exit the anti-virus or virus protection softwares in your computer. The software installation instructions in this manual are based on Microsoft Windows 7 system.

There is an installation disc in the accessory box. Insert the installation disc and you can see the instructions. You can open the disc by manual if you do not see.

Follow the instructions and complete the installation of the whiteboard software. For complete functions, you can click Full Installation and complete the installation as the instructions show. The computer needs to restart so as to activate the software after installation completed. Save all the files in the computer and restart .

Calibration

To work normally, the strokes on the whiteboard should coincide with the actual ones so as to calibrate accurately. The following situations need a calibration.

- The whiteboard is used for the first time.
- The whiteboard softwares have been reinstalled or updated.
- The position of the whiteboard or projector is changed.
- The computer connected to the whiteboard is changed.
- The computer's resolution ratio or refresh rate is changed.
- Calibration deviation caused by other reasons.

Steps are as follow:

Step 1: Connect all necessary devices and make sure the whiteboard service program has been auto-runed once the computer is power on. If not, click "Start-All Programs-HHAP-WhiteBoard Driver-WhiteBoard Driver" and run the whiteboard service program.

Step 2: Wait for seconds and the whiteboard drive icon in taskbar notification area will turn green from red and this indicates that the device and drive are connected.



The service program icon has two status: Icon turns red when the whiteboard and program are disconnected; icon turns green when whiteboard can work normally. To work normally, the whiteboard and computer should be connected correctly and service program icon is green.

Step 3: Adjust the projection angle and make sure the projection area is within the whiteboard display area.

Step 4: Mouse click the whiteboard service program icon at the bottom right of the screen and you can see the following:

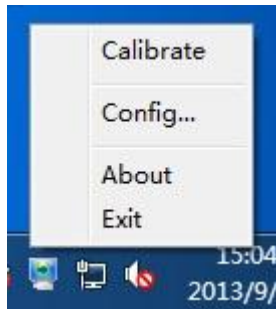

Click "Calibration" and the whiteboard will be in calibration interface as follow:

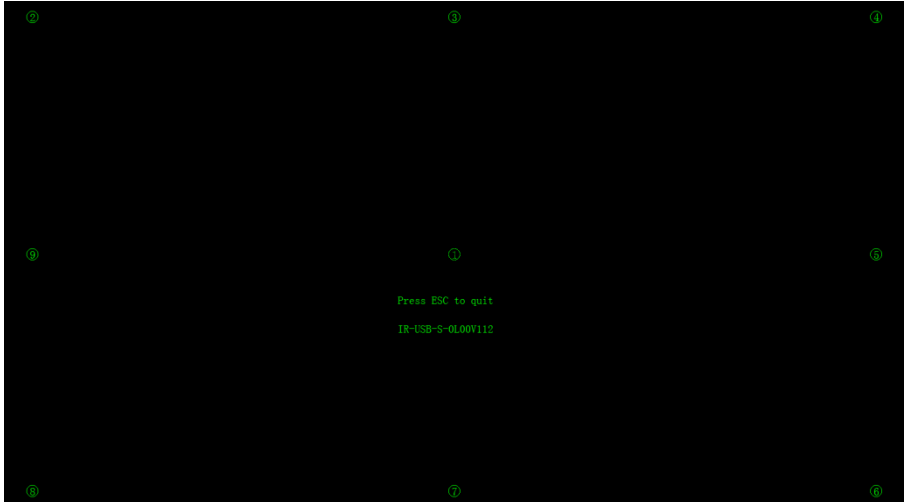

Step 5: Vertically touch the centre of the flashing "+" with the interactive whiteboard pen tip until the flashing "+" move to the next calibration point and thus one point is calibrated. Follow the instructions in the calibration

interface and complete the calibration of other points thus the interactive whiteboard calibration is finished.

 Notes:

- Calibration with a finger might lead to inaccurate calibration. Calibration with the pens will gain a better effect.
- Wrong calibration may lead to whiteboard not working and this requires recalibration.
- Pressing "ESC" during calibration can cancel the current calibration operation.
- There are minor differences between the calibration interface of different version softwares. The calibration, however, is very much the same. For products with shortcut keys, there are shortcut-key calibration and you just need to follow the instructions.
- When a laptop pc with windows 8 system connect a whiteboard touch screen, and set the projective mode as "Duplicate" mode, in some resolution, the laptop may can't get full screen display, then the calibration accuracy in the whiteboard touch screen will not be accurate too, so please select others resolution which can be displayed fully by the laptop pc to avoid this problem.

How to Use the Whiteboard

The whiteboard can be normally used after calibration finished. Common computer operations can be realized without opening the writing software.

Left Click Clicking the whiteboard with a finger or pen has the same effect as mouse left click. Normally it is for selection or pointing.

Double Click Double clicking the whiteboard with a finger or pen has the same effect as mouse double click.

Right Click Touching the whiteboard with a finger or pen for about 2 seconds has the same effect as mouse right click.

Double click the writing software icon on desktop to run the software.



You can also do the following in the writing software:

Write You can write with the pen pressing and sliding on the whiteboard. Operations of drawing and erasing are similar to writing.

Roaming Spread your palm and press the whiteboard with five fingers at the same time and slide then you can have the roaming function.

Tools and Resources The whiteboard with writing software running can realize more functions. You can refer to the writing software user manual for more details.

 Notes:

- When you are roaming with your palm, you need to have five fingers pressing the whiteboard at the same time. Your fingers will be recognized as being writing if they are not pressing at the same time.
- For the best effect, please use the pen in the accessory box or fingers to operate.
- To avoid scratching, do not use other objects instead of the pen. The whiteboard should be carefully kept to avoid cover membrane being scratched.
- Refer to the writing software user manual for more functions and detailed instructions.
- When the DPI (Text Size) is set as “Larger-150%”, the writing software will not work properly. Please enable the “Use Windows XP style DPI scaling” item in “Custom DPI Setting” menu to make the writing software work

How to Use the Smart Pen Tray

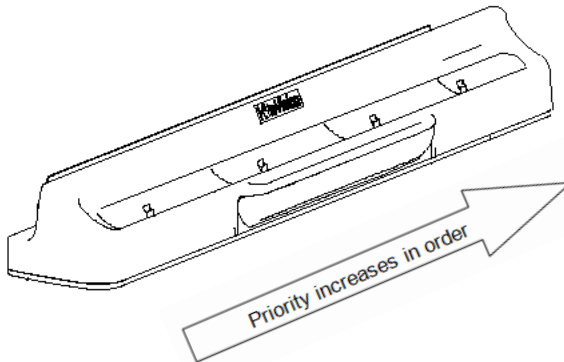

The smart pen tray can contain three whiteboard pens and one eraser. The slots on the pen tray from left to right are for red pen, black pen, blue pen and eraser. And all of them have priority properties: The eraser has the top priority, then blue pen, black pen and lastly the red pen. When you pick up a pen from the pen tray and write on whiteboard, the stroke color is what the slot represents. When you pick up several pens from the pen tray, the stroke color will be what the slot which has the highest priority represents.

When pens are picked up from the pen tray, you can choose the stroke color from the software tools bar. Put the pens into corresponding slot in the pen tray when you are not going to use them.



























The drive icon is green when the service program and whiteboard are connected. If the writing software is not open, you can use the eraser or any pen from the pen tray to open the software and create a new white page. If the writing page is open, you can use the eraser or any pen from the pen tray to switch other interface to writing software interface.

 Notes:

- The stroke colors are only associated with the pen tray slots and have no relation with pen colors.
- When pens are in the pen tray, for convenience, the pen colors should be correspondent with the color marks in the pen tray slot.
- The pen tray slot has built-in PCBs. Do not put other objects in it. Do not expose the pen tray to liquid. Clean the dust in the pen tray slot with a dry cloth regularly. The pen tray might work abnormally if it is not cleaned for a long time.

Screen Keys

Screen keys are called hot keys as well. If the whiteboard is set with hot keys and WhiteBoard is not running, you can run Whiteboard by clicking the hot keys. You can realize the normal functions by clicking the hot keys when the Whiteboard is running.

	Page Up		Image Library
	Page Down		Save
	Whiteboard Page		Change Background Color
	Blackboard Page		New Slide
	Screen Annotation		Previous Slide
	Adjust stroke width		Next Slide
			Preset Property Pen
			Set Pen Width
	Save		Select
	Undo		Undo
	Eraser		Region Eraser
	Return		Switch Mode
			Textbox
			User-defined Key
			Delete Slide

	Timer/Clock
	WrapScreen
	SpotLight
	New White Slide
	Switch Mode
	Screen Annotation
	Rover
	Pen
	Set Pen Width
	Textbox
	Screen KeyBoard
	ImageCapturer
	Image Library
	Region Eraser
	Undo
	Next Slide
	Previous Slide
	Copy
	Cut
	Paste
	Enter
	Tab
	Esc
	Backspace
	Calibrate

Different models have different hot key functions. Refer to the above hot key explanations according to the actual models your purchased.

Trouble Shooting

Solutions to Problems			
Problems	Phenomenon	Presumable Causes	Solutions
Interactive whiteboard is not working.	No service program icon on the right bottom of the computer.	Service program is not started up.	Start up the service program.
		Service program is not installed.	Install the service program.
	Drive icon is red.	The whiteboard is not connected to the computer.	Connect the whiteboard and computer with the USB cable.
		The self-checking of whiteboard is not successful and can not be connected.	Check if there is any other objects pressing on the surface of the whiteboard. Remove if any.
		Drive malfunction.	Uninstall the drive and reinstall it.
	Drive icon is green.	Inaccurate calibration.	Refer to instructions above and recalibrate.
Some calibration points can not be seen during calibration.	No green crossed cursor on whiteboard.	The projector is not adjusted correctly so that part of the image is outside the whiteboard projection area.	Adjust the projector.
Cannot write	Mouse pointer can move but no writing stroke.	The software is not under writing mode.	Shift to writing mode and set mouse status as pen.
	Mouse pointer can	The current stroke color	Change the stroke color

	move under desktop operation mode but cannot write under writing mode.	is same with the background color.	or background color.
The pen is working but there are deviations.	Part of the whiteboard have large deviations.	Inaccurate calibration.	Recalibrate correctly.
		There is projection distortion.	Adjust the projector.
The pen is working but reactions are slow.	The strokes do not sync with the writing and there is a delay.	Conflict with anti-virus softwares.	Exit the anti-virus softwares.
		The computer is running too many softwares.	Exit the softwares which will not be used at present.
		The computer's hardware configuration is too low.	Contact professional personnel to upgrade the computer hardware.
The pen tray is not working normally.	Cannot change the stroke color when picking up or putting down the pen from the pen tray.	There are other objects or dust in the pen tray slots.	Remove other objects or clean the dust from the pen tray slots.
		The pen tray is not fixed firmly to the whiteboard or not well-connected with the whiteboard.	Take off and re-plug the pen tray and screw firmly on the bottom of the pen tray.

Specifications

Technology	Infrared
Touch System	Pen, Finger
Resolution	32767 X 32767
Tracing Velocity	125 P/S
Scan Period	≤8ms
Consumption(Wired)	Power< 1W
Port	USB
Operation System	Microsoft Windows XP/Vista/Win7/Win8
Operation Temperature	-15°C ~ 50°C
Operation Humidity	20~90%
Storage Temperature	-40°C ~ 50°C
Storage Humidity	10~95%

We commit ourselves to product upgrading and technology improvement. The contents in this manual are subject to be changed without prior notice.