

newline

Interactive Flat Panel Display

User Manual

S Series



Contents

About This Document	4
1 Overview	9
1.1 Parts.....	9
1.2 Ports.....	11
1.3 Front Buttons.....	13
1.4 Remote Control.....	14
2 Installation Guide.....	17
2.1 Safety Precautions.....	17
2.2 Installation Precautions.....	18
2.3 Installation.....	20
2.4 Installing the OPS (Optional).....	21
2.5 Installing the Wi-Fi Module.....	22
3 Getting Started	24
3.1 Power On.....	24
3.2 Power Off.....	24
3.3 Calibration.....	25
4 Operating	28
4.1 Start Screen	28
4.2 Home	28
4.3 Sources	32
4.3.1 Built in PC.....	32
4.3.2 Signal source	32
4.3.3 Screen Sharing	33
4.4 Applications.....	34
4.4.1 Whiteboard	34
4.4.2 Annotation	49
4.4.3 File Management.....	52
4.4.4 Application program.....	55
4.4.5 Settings.....	69
5 Quick Setting Menu	84
5.1 Quick Setting Menu	84
5.2 Automatically Power Off	85
6 Serial Port Control.....	86
7 FAQs & Troubleshooting	93
8 Specifications	96

Thank you for choosing Interactive Flat panel display. Please use this document to get the most out of your screen.

This device complies with part 15 of the FCC Rules. Operation is subject to the following two conditions: (1) This device may not cause harmful interference, and (2) this device must accept any interference received, including interference that may cause undesired operation.

NOTE 1: This equipment has been tested and found to comply with the limits for a Class B digital device, pursuant to part 15 of the FCC Rules. These limits are designed to provide reasonable protection against harmful interference in a residential installation. This equipment generates, uses, and can radiate radio frequency energy and, if not installed and used in accordance with the instructions, may cause harmful interference to radio communications. However, there is no guarantee that interference will not occur in a particular installation. If this equipment does cause harmful interference to radio or television reception, which can be determined by turning the equipment off and on, the user is encouraged to try to correct the interference by one or more of the following measures:

- Reorient or relocate the receiving antenna.
- Increase the separation between the equipment and receiver.
- Connect the equipment into an outlet on a circuit different from that to which the receiver is connected.
- Consult the dealer or an experienced radio/TV technician for help.

NOTE 2: Any changes or modifications to this unit not expressly approved by the party responsible for compliance could void the user's authority to operate the equipment.





The symbol of the crossed out wheeled bin indicates this product should not be placed in municipal waste. Instead, dispose of waste equipment by taking it to a designated collection point for electrical and electronic equipment recycling.



About This Document





This document describes multiple functions, instructions, and notes about the product.

Symbols are used in this document to indicate operations that need particular attention. The symbols are defined as follows:

 NOTE	Provides additional information to supplement operation in the main text.
 TIP	Provides tips for operation.
 CAUTION	Indicates a potentially hazardous situation that, if not avoided, could result in equipment damage, data loss, performance deterioration, or unanticipated results.
 WARNING	Indicates a hazard with risk that, if not avoided, could result in death or injury.

Safety Instruction

For your safety, please read the following instruction before you use the product. Serious injury or property damage may be caused by improper operations. Do not try to repair the product on your own.

 WARNING	
	<p>Disconnect the product from the power supply immediately if major failures occur.</p> <p>Major failures include the following:</p> <ul style="list-style-type: none"> • If smoke, a peculiar smell or an abnormal sound is discharged from the product. • No image or sound is displayed, or the image error occurs. <p>In the preceding scenarios, do not continue to use the product. Disconnect power supply immediately and contact professional staff for troubleshooting.</p>
	<p>Do not drop any liquids, metal, or anything combustible onto the product.</p> <ul style="list-style-type: none"> • If any liquids or metal are dropped onto or into the product, power off the product and disconnect the power supply. Then contact professional staff for solutions. • Pay attention to children when they are close to the product. <p>Put the product on a stable surface.</p> <p>An unstable surface includes, and is not limited to, an inclined plane, a shaky stand, desk or platform, that might cause the product to turnover and be damaged.</p>
	<p>Do not open the panel or change the product on your own.</p> <p>High voltage components are installed in the product. When you open the panel, high voltage, electric shock, or other dangerous situations may occur.</p> <p>If inspection, adjustment, or maintenance is required, contact the local distributor for help.</p>
	<p>Use the provided power supply.</p> <ul style="list-style-type: none"> • To prevent the product from being damaged, do not use any types of power cables other than the one provided with the product. • Use a three-wire socket and ensure that it is properly grounded. • Pull out the power plug from the socket if the product is not used for a long period. <p>Clean the power plug regularly.</p> <ul style="list-style-type: none"> • Fire or electric shock may be caused if the product is powered on while you are cleaning. • Pull out the power plug before cleaning it with a dried cloth. <p>Power output port is 5V/2A.</p> <p>The voltage/current of the rear power output port is 5V/2A (maximum). Purchase the power code/AC adapter according to customer needs. Please do not connect any products with different power requirement. Otherwise, it may cause damage to products or fire.</p>



WARNING

	<p>Do not put items on the top of the product.</p> <ul style="list-style-type: none">• Do not put items, such as a container for liquid (a vase, flowerpot, cosmetics, or liquid medicine) on the top of the product.• If any water or liquid is spilled on the product, the product may short circuit and cause fire or electric shock.• Do not walk on or hang any items on the product.
	<p>Do not install the product in an improper place.</p> <ul style="list-style-type: none">• Do not install the product in humid places, such as the bathroom, the shower room, near windows, or outdoor environments that experience rain, snow, or other harsh weather. Avoid installation near hot spring vapor. The preceding environments may cause faults in the product or electric shock under extreme conditions.• Do not put an exposed fire source, such as a lit candle, on the product.
	<p>Pull out the power supply during thunderstorms.</p> <ul style="list-style-type: none">• Do not touch the product during a lighting storm, you may experience an electric shock.• Install or place components that supply high enough voltage to cause personal injury out of the reach of children.
	<p>Do not touch the power cable with wet hands.</p>



CAUTION

	<p>Do not install the product in high temperature environments.</p> <ul style="list-style-type: none">• Do not install the product near a heat source, such as a radiator, a heat reservoir, a stove, or other heating products.• Do not expose the product to direct sunlight, which may cause high temperatures and subsequent faults in the product.
	<p>When transporting the product:</p> <ul style="list-style-type: none">• Pack the product for transport or maintenance by using the cartons and cushioning material provided with the product.• Move the product vertically during transport. The screen or other components are easily broken if the product is moved in an improper way.• Before you move the product, disconnect all external connections and separate all topple preventing products. Move the product carefully to prevent it from being hit or squeezed, especially the screen, which may cause injury if broken.
	<p>Do not cover or block up any vents on the product.</p> <ul style="list-style-type: none">• Any overheated components may cause fire, damage the product, and shorten the service life.• Do not lay the product down in a way where the venting surface will be covered.



CAUTION

- Do not install the product on carpet or cloth.
- Do not use a cloth, such as table cloth, to cover the product.



Keep the product away from the radio.

The product complies with the international EMI standard to prevent radio interference. However, interference may still exist and causes noise in the radio. If noise occurs in the radio, try the following solutions.

- Adjust the direction of the radio antenna to avoid the interference from the product.
- Keep the radio away from the product.

If the screen glass is broken or falls off:

- Keep all personnel 10 feet away from the screen to ensure safety.
- Do not perform any installation or disassembly while the screen glass is broken or has fallen off.

Use the battery correctly.

- Galvanic corrosion, electric leakage, and even fire may be caused by improper battery usage.
- It is recommended to use the designated type of battery and install the battery by the correct electrodes (positive and negative).
- Do not install and use a new battery with a used one.
- Take out the battery if the remote control is not used for a long period.
- Do not expose the battery to overheated environments, such as sunlight or heat sources.
- Dispose of the used battery based on your local regulations.

Do not damage the power cable.

- Do not damage, change, twist, bend, or forcibly drag the power cable.
- Do not put weights (such as the product itself) on the power cable.
- Do not forcibly drag the cable when you pull out the power plug. If the power cable is damaged, please contact the local distributor to repair or replace it.
- The power cable in the accessory box is for this product only. Do not use it on other products.

Additional advice:

- Use the product in an environment with comfortable lighting. It is harmful to your eyes to watch in a too bright or too dark environment.
- Relax your eyes watching for a period of time.
- Keep sufficient distance from the product to protect your eyes and prevent eyestrain.
- Adjust the volume to an appropriate level, especially at night.
- Excessive sound pressure from ear-/headphones can cause hearing damage/hearing loss.
- Adjustment of the volume control as well as the equalizer to other settings than the center position may increase the ear-/headphones output voltage and therefore the sound pressure level.
- The use of factors influencing the ear-/headphones output other than those specified by the manufacturer (e.g. operating system, equalizer software, firmware, driver) may increase the ear-/headphones output voltage and therefore the sound pressure level.
- The use of ear-/headphones other than those specified by the manufacturer may lead to



CAUTION

heightened sound pressure level.

- Use amplifier equipment as the audio input source with caution. If you must use amplifier equipment, the input power should not exceed the maximum of speaker power. Otherwise, the speaker can become overpowered and damaged.

About USB port.

Front USB ports and rear USB 3.0/USB 2.0 ports switch connections based on signal sources. If the current signal source is reading the data from an external product connecting to the port, please switch the signal source after the data reading is complete. Otherwise, the data or product may be damaged.

1 Overview

1.1 Parts

- Front View



- Rear View

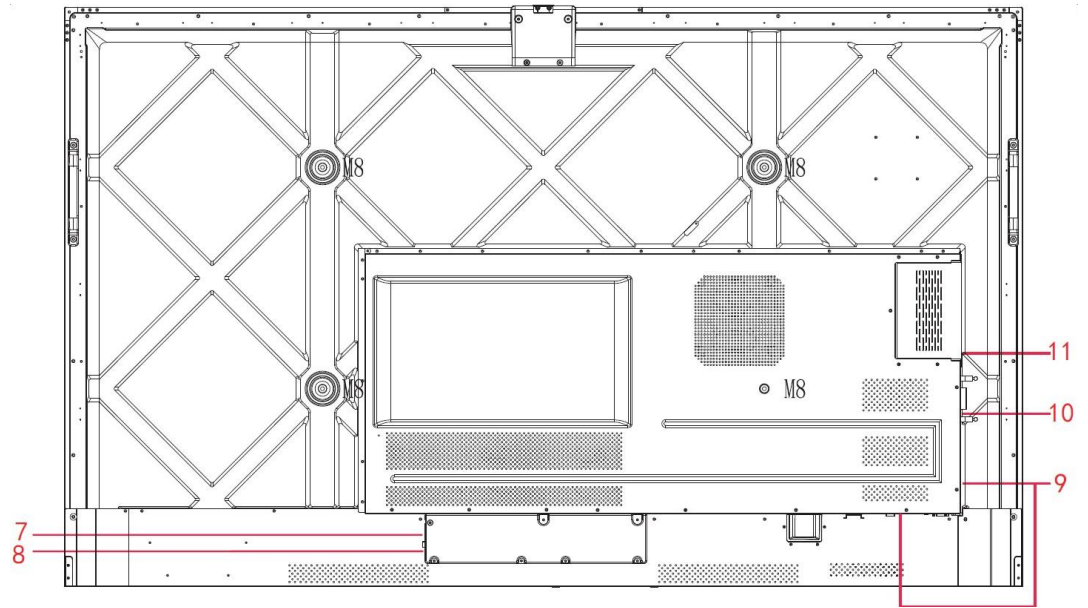

1	Power On/Off	7	Power Supply Plug
2	Front Buttons	8	Power Switch
3	Remote Control Receiver	9	Rear Ports
4	Light Sensor	10	Wi-Fi Module Slot
5	Front Ports	11	OPS Slot
6	Speakers		

Notes:

The product images shown are for illustration purposes only and may not be an exact representation of the product.

1.2 Ports



- *Front USB ports and rear USB 3.0/USB 2.0 ports switch connections based on signal sources. If the current signal source is reading the data from an external product connecting to the port, please switch the signal source after the data reading is complete. Otherwise, the data or product may be damaged.*
- *For USB use, USB 2.0 provides up to 500Ma whereas USB 3.0 provides up to 900Ma of power. Please make sure the USB flash drive is formatted to FAT32 before inserting into the panel.*
- *Please use the supplied cable in the accessory box or the HDMI association certified shielded cable to better ensure the signal quality.*
- *While HDMI and Display Port offer support for cables of varying lengths, the maximum cable length that the panel recommends for optimal performance is 3 meters (10 feet) for HDMI and 1.8 meters (around 6 feet) for Display Port. Using cable longer than recommended length may cause data loss and a negative impact to display quality.*

Camera port

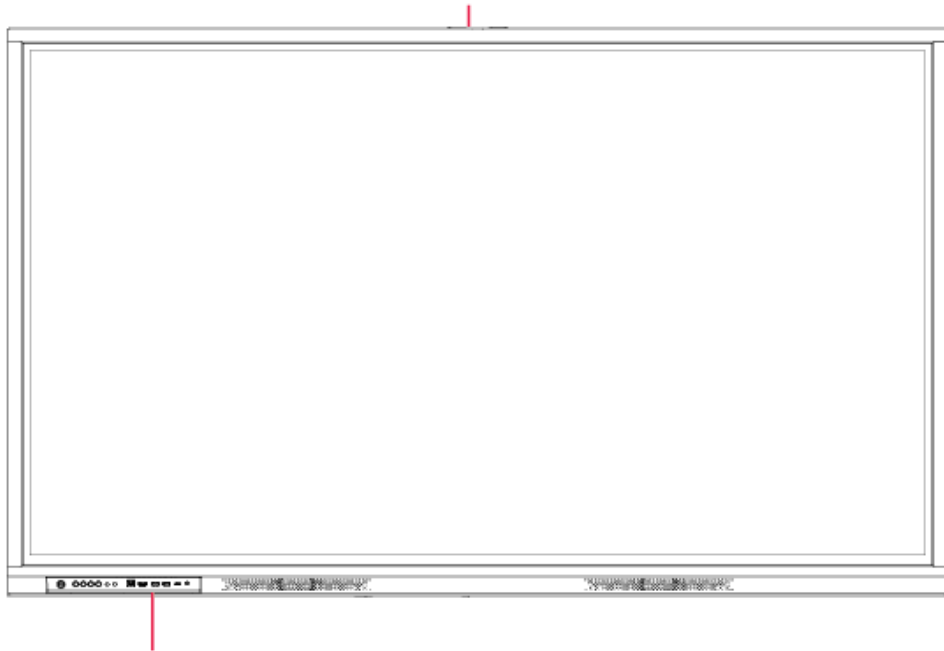

Touch



HDMI



USB3.0

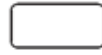

USB3.0



Type-C



MIC







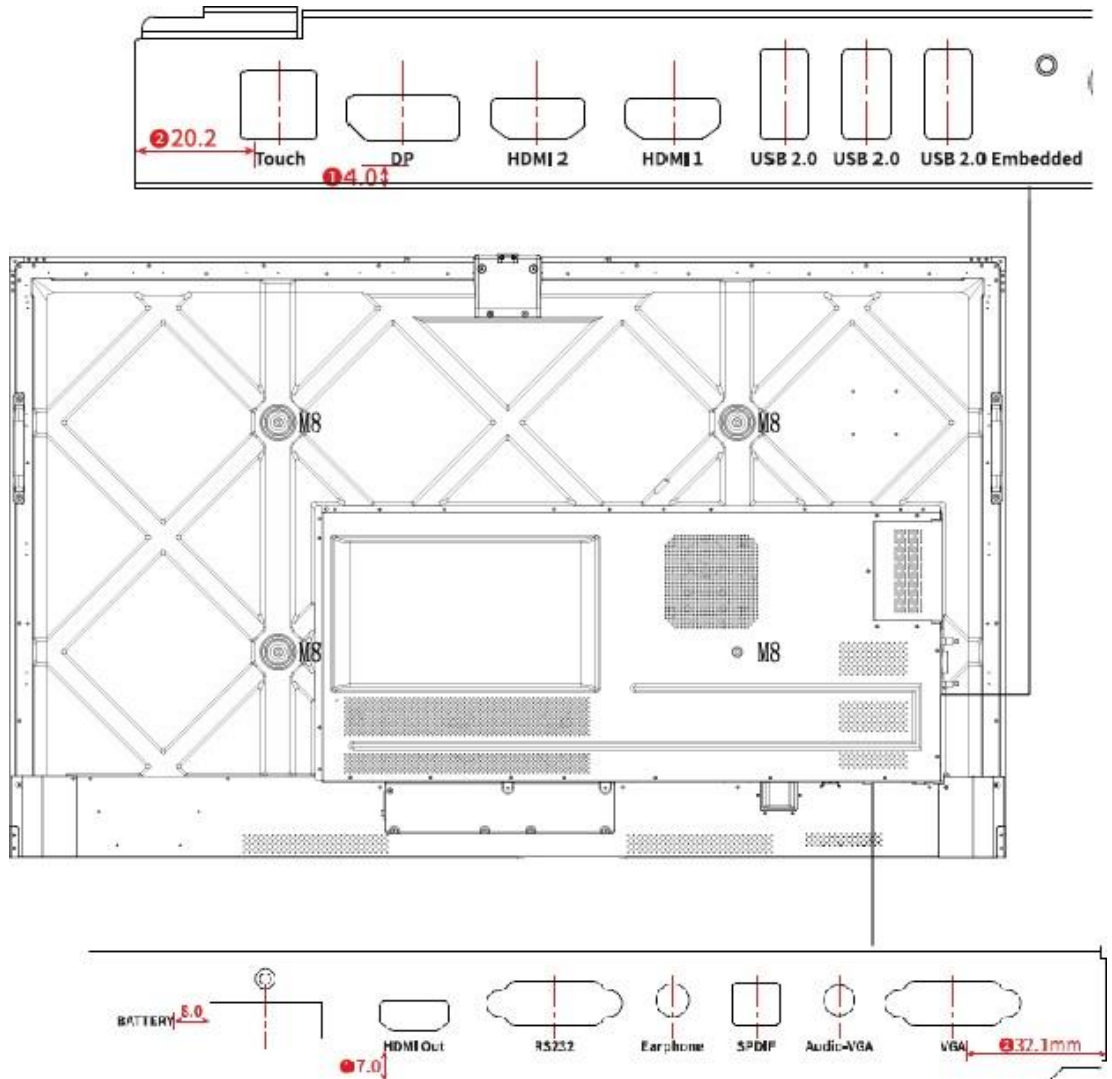

WARNING

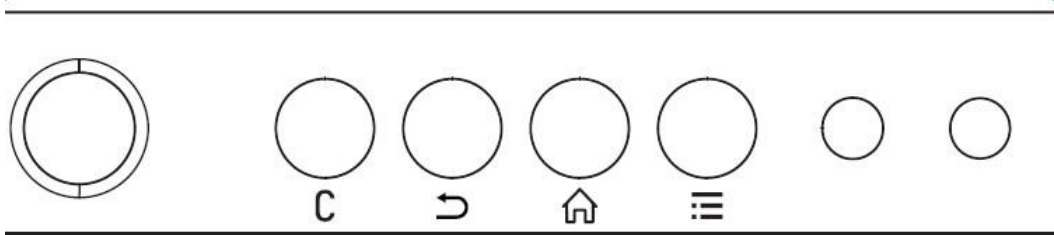
The rear power output port supplies 5 V/2 A (maximum) power. Please purchase the power AC adapter for powering external devices. Please do not connect any products which require power than listed. Doing so may cause injury or damage to the panel.



1.3 Front Buttons

























Buttons	Operations	Functions
	Short press	Power on <ul style="list-style-type: none"> • Solid white color : Display is on and working Sleep mode <ul style="list-style-type: none"> • The red and white lights flicker alternately: Display enter Sleep mode.
	Long press for more than 2 seconds	Power off <ul style="list-style-type: none"> • Solid red color : Display is in shut down mode
	Short press	Enter the customization page. Note: C function can be set in Settings> input/output setting.
	Short press	Back to the previous menu.
	Short press	Go to the home page
	Short press	Open the Quick Setting menu
	Long press for 5 seconds	Activate/Exit the child Lock Function

1.4 Remote Control



Carefully read the following instructions before using the remote control to avoid possible faults:

- Do not drop or damage the remote control.
 - Do not spill water or other liquids on the remote control.
 - Do not place the remote control on a wet object.
 - Do not place the remote control directly under sunlight or near a heat source.
-

Buttons	Functions	
	Power on/off	
	Mute or unmute	
0-9	Numbers	
	Return to homepage	
	Press once to return to the previous page	
	Enter the whiteboard application	
	Take a Screenshot	
	Up/Down/Left/Right selection button	
	Confirmation button	
	Enable Sound Only Mode	
	Freeze the Current Screen, press again to Exit Freeze Function	
	Adjust the Sound Volume	
	Adjust the Brightness	
	Enter the Source Selection Page	
	View Currently Running Applications	
	Open the File Manager	
	View all Pre-installed Applications	
	Open the Browser Application	
	Auto correction Screen Display (For VGA Signal Source)	
	Start/Exit the Screen Lock Function	
	Enter the D.Mode	
	Enter the Settings page	
	Enter the Quick Setting menu	
Type-C	Switch to Type C source	
DP	Switch to DP source	
FRONT HDMI	Switch to HDMI Front source	
1 HDMI	Switch to HDMI Rear 1 source	

Buttons	Functions	
2 HDMI	Switch to HDMI Rear 2 source	
VGA	Switch to VGA source	

2 Installation Guide

2.1 Safety Precautions

Installation Environment



Installation Direction

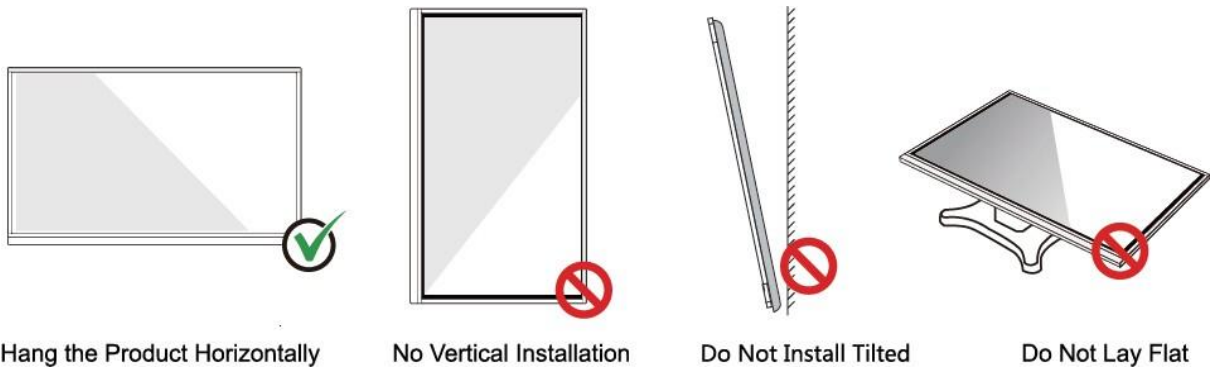

2.2 Installation Precautions

Weight Loading

- When using a mobile stand, ensure that the weight of the product is less than the loading capacity of the mobile stand.
- When using the wall-mount bracket, ensure that the wall can support the weight of the product. We recommend that the wall surface be reinforced and have a loading capacity 4 times of the weight of the product. Consult a professional installer for wall-mount installation.
- Attaching the VESA Mounting Bracket. This apparatus is intended to be supported by a GS Listed wall-mount bracket.

NOTE

The company does not undertake relevant legal responsibility for any problems caused by improper operation if the third party mobile stand, or wall-mount bracket is beyond the scope of the product.

- Do not install the product where it might be hit by an opening or closing door.

Vertical installation

When installing the panel, try to keep the panel vertical. An excessive tilt angle may cause damage to the glass or other internal components.

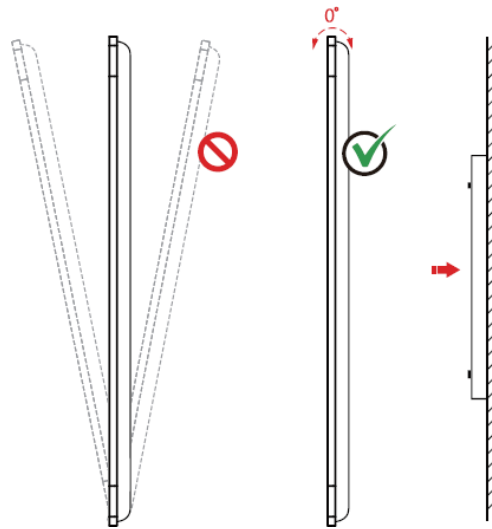

NOTE

For any problem, please contact our support desk. Our company is not responsible for any damage or losses incurred by users if the users fails to follow the instructions.

Ventilation

Ensure adequate ventilation and/or an air conditioned environment. We recommend keeping certain distances from the side of the product to the wall or panels. Ventilation requirements are shown in following figure:

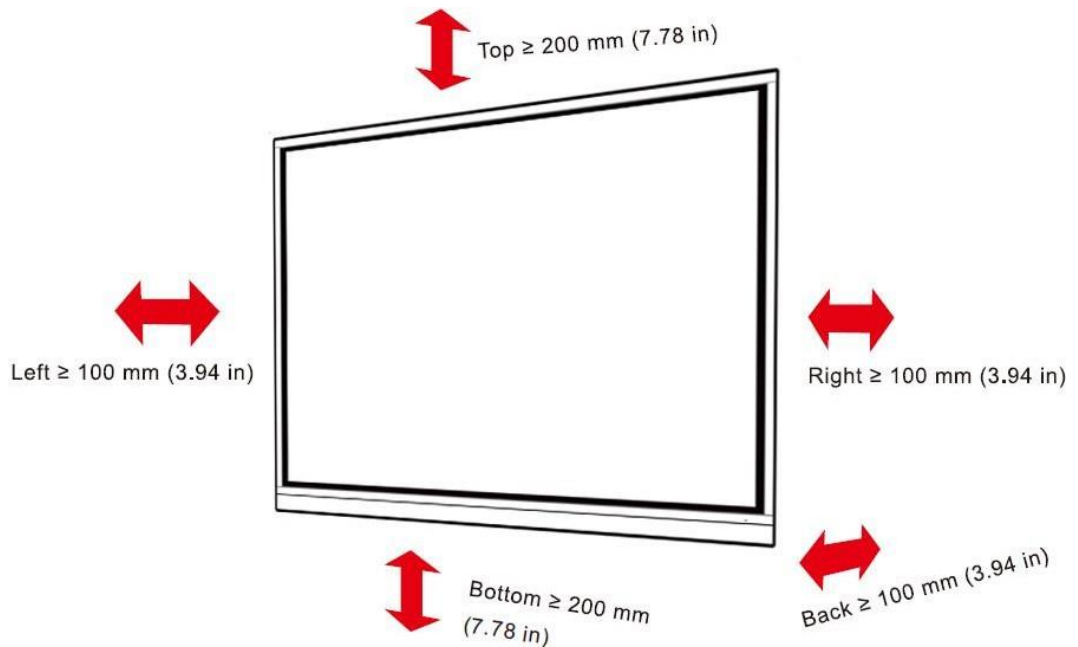

2.3 Installation

The dimensions of the four bracket mounting holes on the back panel are VESA MIS-F compliant (86INCH or 75INCH: 800 x 400 mm/31.50 x 15.75 in; 65INCH: 600 x 400 mm/23.62 x 15.75 in). Use metric M8 screws with a length of 10 mm to 15 mm (0.40 to 0.59 in) to secure the touchscreen to the mounting system. Dimensions of the mounting holes on the back panel are shown on the following figure:



NOTE

Consult a professional installer to install the display product.

75"/86":

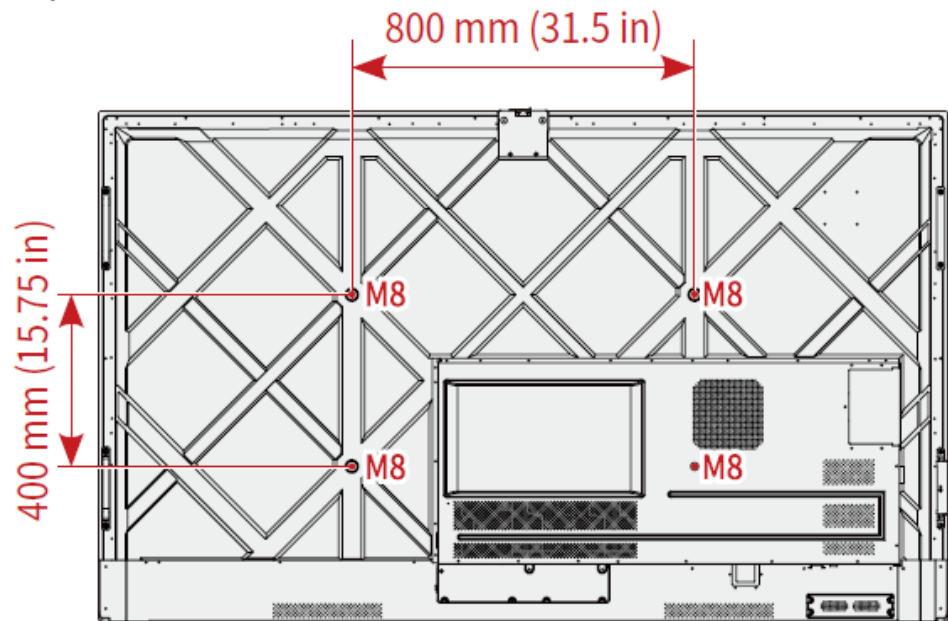

65 inch:

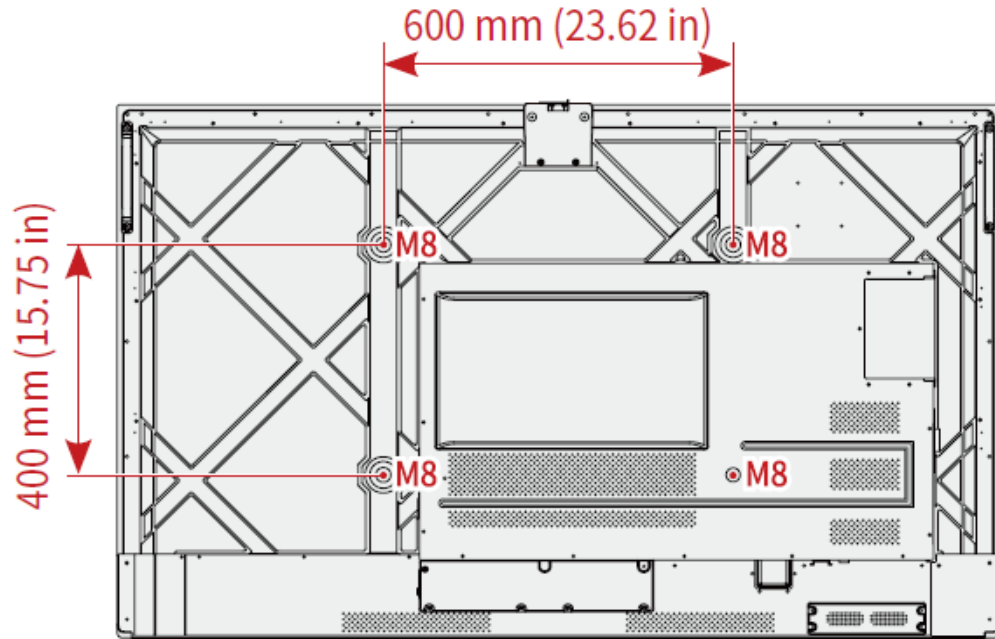

2.4 Installing the OPS (Optional)



The OPS does not support hot plugging. Therefore, you must insert or remove the OPS when the display is powered off. Otherwise, the display or OPS may be damaged.

You will need to purchase the OPS separately. Perform the following steps to install the OPS.

Step 1 Unscrew the M4 screws by hand to remove the OPS protective cover.

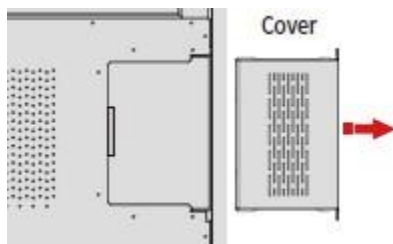

Step 2 Push the OPS into the OPS port on the rear of the panel until firmly seated, using the M4 screws to secure the OPS.

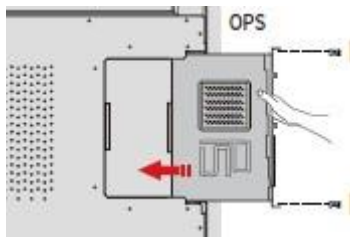

2.5 Installing the Wi-Fi Module



CAUTION
Wi-Fi Module *does not support hot plugging. Therefore, you must insert or remove the Wi-Fi Module when the display is powered off. Otherwise, the display or Wi-Fi Module may be damaged.*

Perform the following steps to install the Wi-Fi Module.

Step 1 Unscrew the 2 screws on the Wi-Fi Module port and remove the shielding cover.

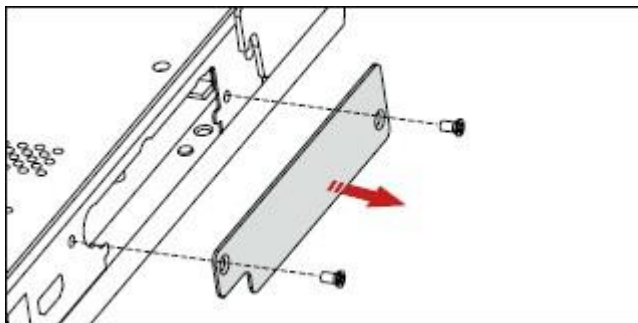

Step 2 Insert the Wi-Fi Module into the port on the rear of the panel until firmly seated, using the 2 screws to secure it.

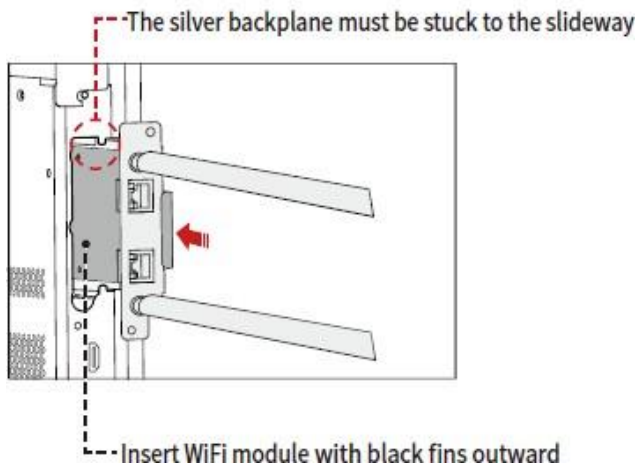
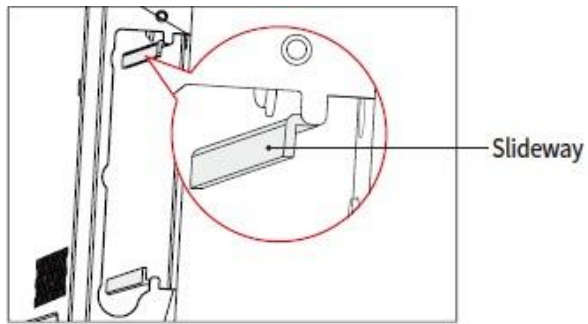

3 Getting Started

3.1 Power On

Step 1 Ensure the power cable is fully seated into the panel and wall outlet before powering on the panel. Please confirm your wall outlet supports a power range of 100V to 240V with frequency at 50 Hz/60 Hz \pm 5% and is fully grounded.



NOTE



The power outlet should be installed near the equipment and should be easily accessible.

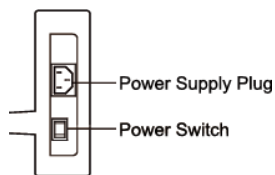

Step 2 Flip the power switch located on the side of the product to “I”.



Step 3 Press the power button  on the front control panel or  on the remote control.

3.2 Power Off

Step 1 Press the power button  on the front panel or the power button  on the remote control to enter sleep mode.

Step 2 Long press the power button  on the front panel or the power button  on the remote control, The **Warning** dialog box will be displayed as shown in the following figure.

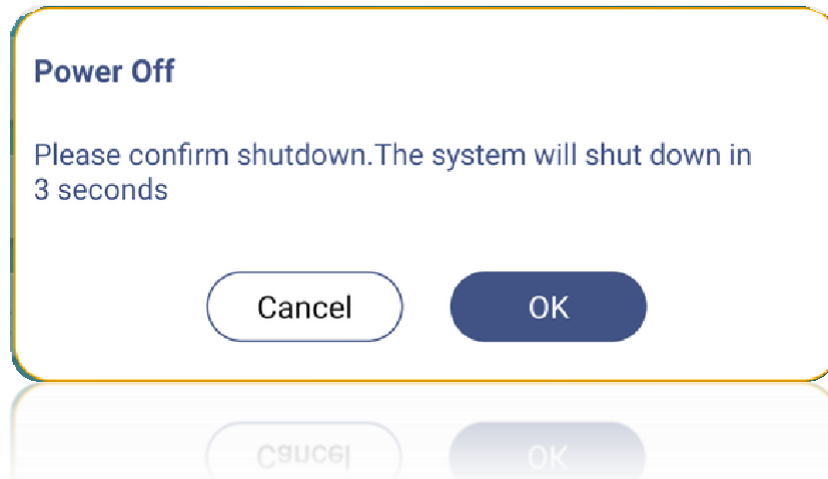

Step 3 In the **Warning** dialog box, tap **Cancel** to return to working mode. Tap **OK** to turn off the panel, and the power indicator will turn to red.

Step 4 If you want to completely turn off the product, turn off the rocker switch behind the panel (next to the power socket) and unplug the power cord.



NOTE

- If an OPS is installed, the OPS and the screen will simultaneously powered off when the power is shutoff.
- Please properly shut down the panel before disconnecting the power source or it may cause damage. Accidental power failure may cause damage to the panel.
- Do not repeatedly turn the power on & off in a short period of time as it may cause malfunction.

3.3 Calibration

If the cursor position has a big deviation from the actual touch point, calibration is used to eliminate the deviation. Calibration is required in the following scenarios:

- The OPS is used.
- A computer is connected through the HDMI or Display Port interface.



NOTE

Interface operation on the embedded operating system does not need positioning. External products with Microsoft Windows 7 or later versions will require positioning.

If the positioning is not correct, perform the following operations to calibrate again. The following takes Windows 10 as an example:

Step 1 Ensure that the HDMI or DP interface and external products are connected properly.

Step 2 Select the corresponding Windows signal from the signal source menu. The Windows page will be displayed.

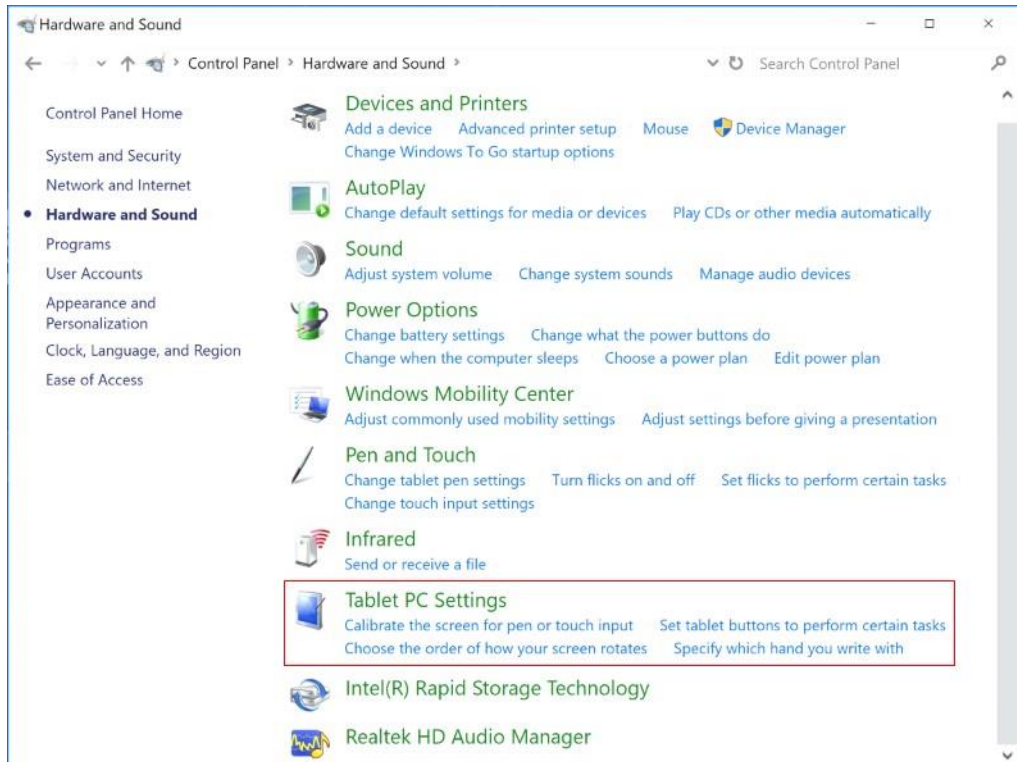

Step 3 Select **Tablet PC Settings** on the **Control Panel** page.

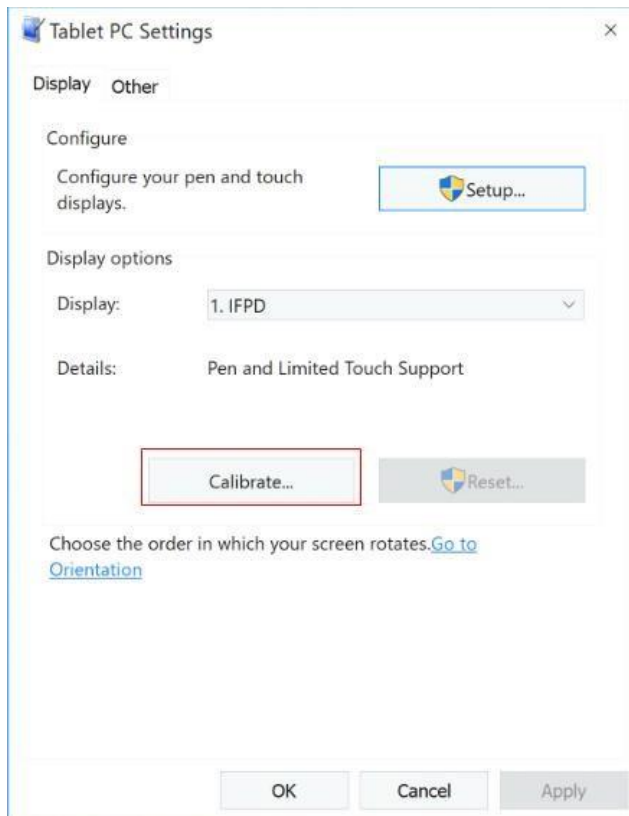

Step 4 Select  in the Tablet PC Settings window.



Step 5 Select **Touch input** from the option and start calibration.

Step 6 Use your finger or a pencil to click and hold the center of the flickering crosshair . Do not release until  moves to the next positioning point. Complete the calibration process as instructed.

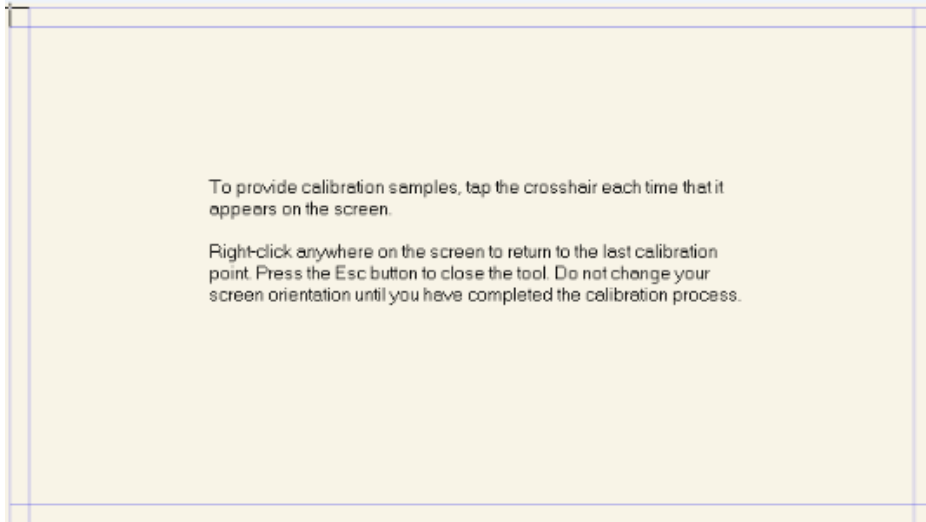

Step 7 After the calibration is complete, the **Digitize Calibration Tool** dialog box will be displayed. Click **Yes** to save calibration data.

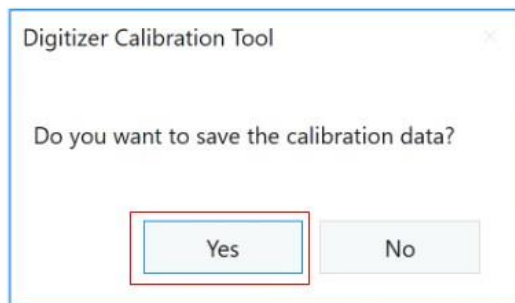

 **TIP**

- To ensure writing accuracy, use the pencil or stylus included with the product for proper positioning.
- Positioning errors may cause failure of touch functions of the display. In that case, please perform calibration again.

Step 8 The **Tablet PC Settings** dialog box will be displayed again. Tap **OK**. The calibration will be complete.

4 Operating

4.1 Start Screen

When the panel is turned on, the panel will show the Start Screen page, as shown in the following figure.

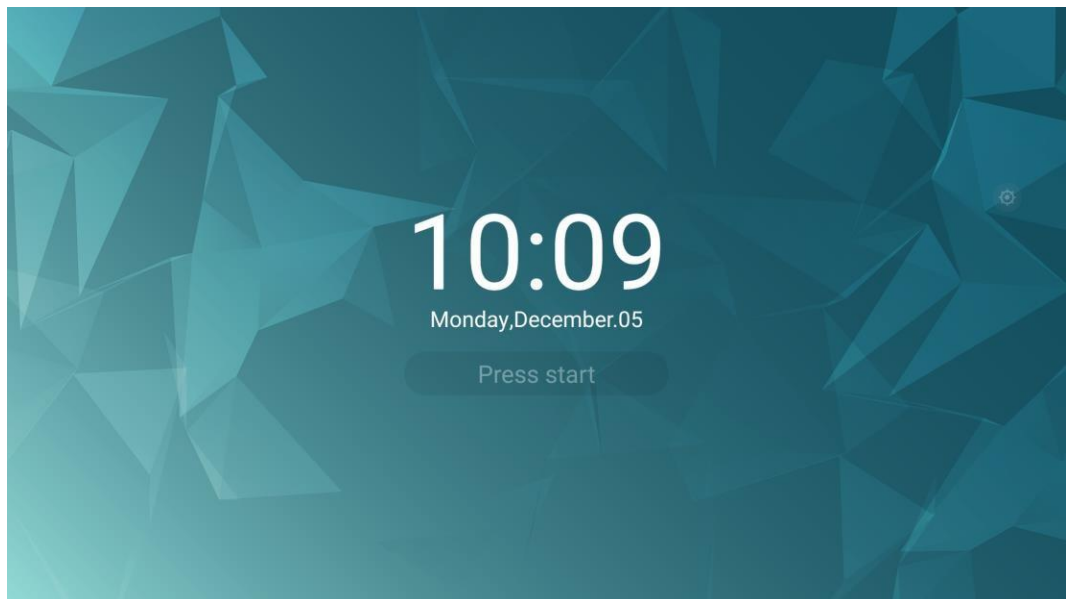

Notes:

If passkey lock function is on, every time you boot up the panel, system will request the passkey.







4.2 Home

Touch the screen to enter the Home page, the user will be taken to the **Home** page as shown in the following figure:



1	Main Toolbar	4	Date and Week(shortcut to calendar)
2	Status Bar and Start Screen Shortcut	5	Floating Toolbar
3	Clock(shortcut to clock)		







Main Icon

Icons	Functions
	Tap the bar to enter the internal PC system or the user may set their favorite source frequently used.
	After the user customizes the signal source, this icon changes accordingly.
	Tap the bar to enter the Source page. Signal sources include Built-in PC, VGA, DisplayPort, Type C, HDMI 2, HDMI 1, and HDMI Front.
	Whiteboard provides discussion board function.
	Tap the bar to share the screen from portable devices, such as laptop and tablet.
	Files is for opening the File Manager, and you can explore on internal and external files of the screen.
	Apps display all pre-installed applications, including Aqual Mail, Browser, Camera, Chromium, Classroom Share, EsharePro, File Commander, Memory Usage, Office Suite, Screen Record, Source Launcher, Visualizer and etc. Tap the icon of an application to run the application.

Icons	Functions
	Tap the bar to enter the setting page.

Status Bar and Settings



The bottom left corner of the Home page displays start screen shortcut and working status icons (including USB flash memory(s), Bluetooth, Ethernet, and Wi-Fi)







Icons	Functions
	Tap the icon to go back to Start Screen.
	If the product is connected to Ethernet, the icon will be displayed. Tap the icon to enter the corresponding setting menu.
	If the product is connected to Wi-Fi, the icon will be displayed. Tap the icon to enter the corresponding setting menu.
	Tap the icon to enter Bluetooth setting.
	If the hotspots function is on, the icon will be displayed.
	If USB flash memory(s) is connected to the USB port, this icon will be displayed. Tap the icon to enter File Commander.  NOTE If the files cannot be saved to a USB flash memory successfully, use a USB flash memory less than 16 GB and change the file system into FAT 32 format.

Floating Toolbar

Pressing any part of the screen with 2 fingers for longer than 2 seconds, the floating toolbar will appear by your fingers. You may hold the center part and move it. After 5 seconds without operation of the toolbar, it gradually becomes translucent. Tap the toolbar or press any part of the screen with 2 fingers for longer than 2 seconds again and you may bring it back.

The functions of the floating toolbar are as follows:

Icons	Functions
	Tap to enter the internal PC source.
	Tap to enter the whiteboard.
	Tap to enter the annotation mode.

Icons	Functions
	Tap to exit from current program or source to the Home page.
	Tap to back to the previous step or exit from current program.
	Tap to enter managing currently running applications. Tap " Clear All " at the upper right corner to clear all applications.
	Tap to expand the slide bar to adjust the volume.
	Tap to expand the sidebar to adjust the brightness.
	Tap to expand or hide the toolbar.

4.3 Sources

4.3.1 Built in PC

On the Home Page, tap **Built in PC** to enter the OPS source, as shown in the following figure. If the display is not equipped with an OPS, "No Signal" is displayed.



4.3.2 Signal source

On the **Home** page, tap **Source** to enter the signal source page, tap **Sources** icon to view the signal source ports, including **Built-in PC**, **VGA**, **DisplayPort**, **Type C**, **HDMI 2**, **HDMI 1**, and **HDMI Front**.

An icon without an active signal source connected will be transparent, an icon with an active signal sources connected will be white, and the icon of the signal source currently being previewed will be blue. After you choose a white icon, the content of the signal source can be displayed in the window for a real-time preview, the icon color will change from white to blue, and the name of the preview window for the signal source will change to match with the signal source being previewed.

- Size: Tap to switch the size of preview window.
- Sound: Tap to adjust the volume.
- Enter: Tap to exit the current signal source.
- X: Tap to close the application.

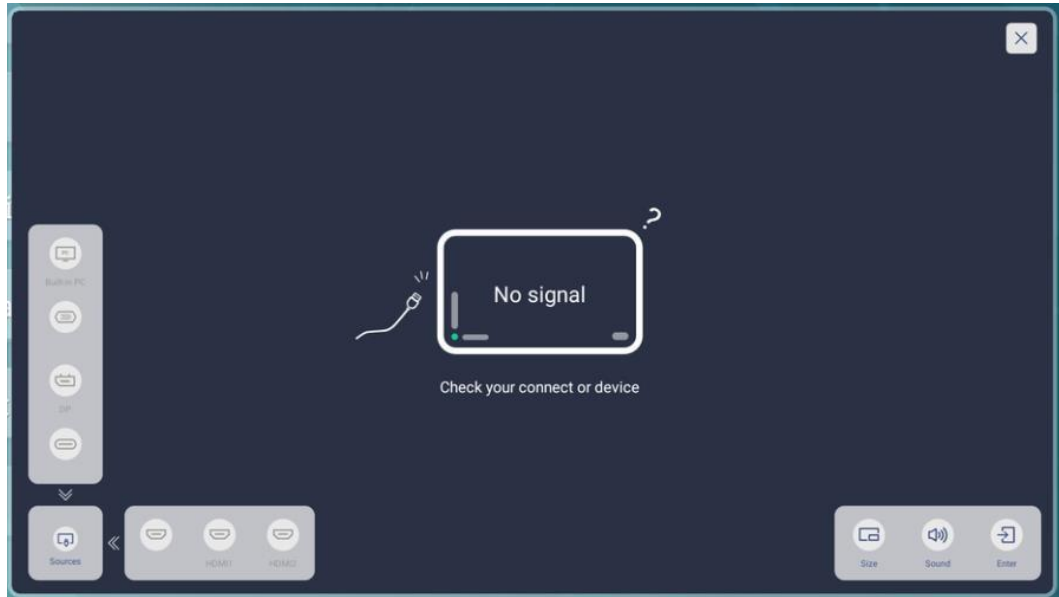

4.3.3 Screen Sharing

Multiple devices can be cast wirelessly to the display through several casting modes (Airplay, Google Cast...). To cast: tap Screen Sharing on the Home Page to enter EShare. On screen directions will appear for you to follow in order to wirelessly cast to the display, as shown in the following figure:

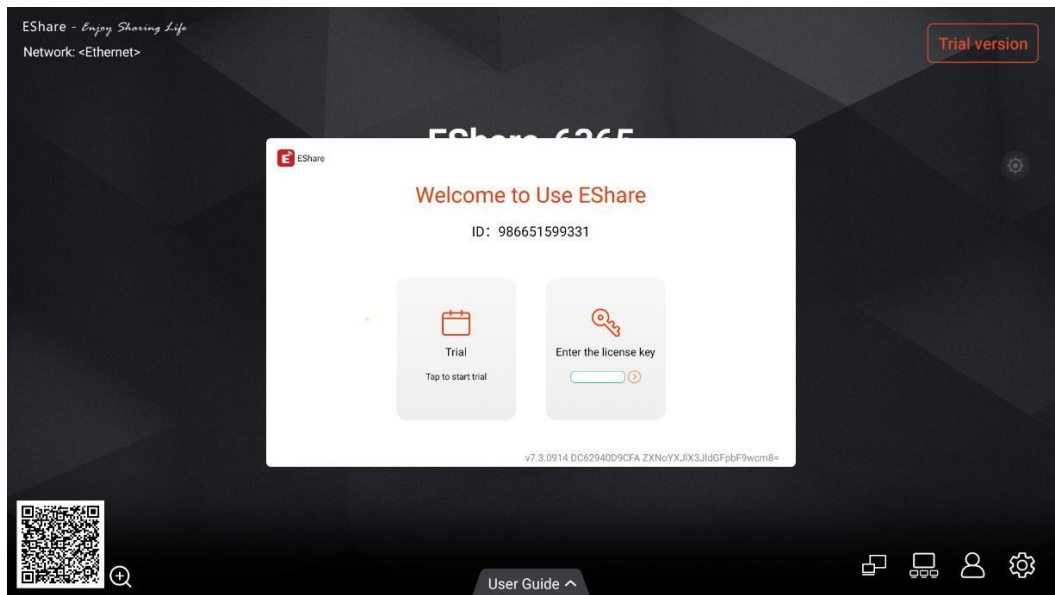

4.4 Applications

4.4.1 Whiteboard

The whiteboard function is designed to present conference writing to attendees quickly and easily. The Whiteboard support 1~4 Points for writing or drawing at the same time, and 5 finger gesture as an eraser.

Whiteboard has the following functions:

- **Discussion**

On the whiteboard page, you can select pen type, width, and color to write or annotate on the screen. You can also erase selected content or clear all contents.

- **Page navigation**

Preview, share or delete pages.

Tap **Whiteboard** on the **Home** page or tap  in the floating toolbar to enter the discussion mode, as shown in the following figure.

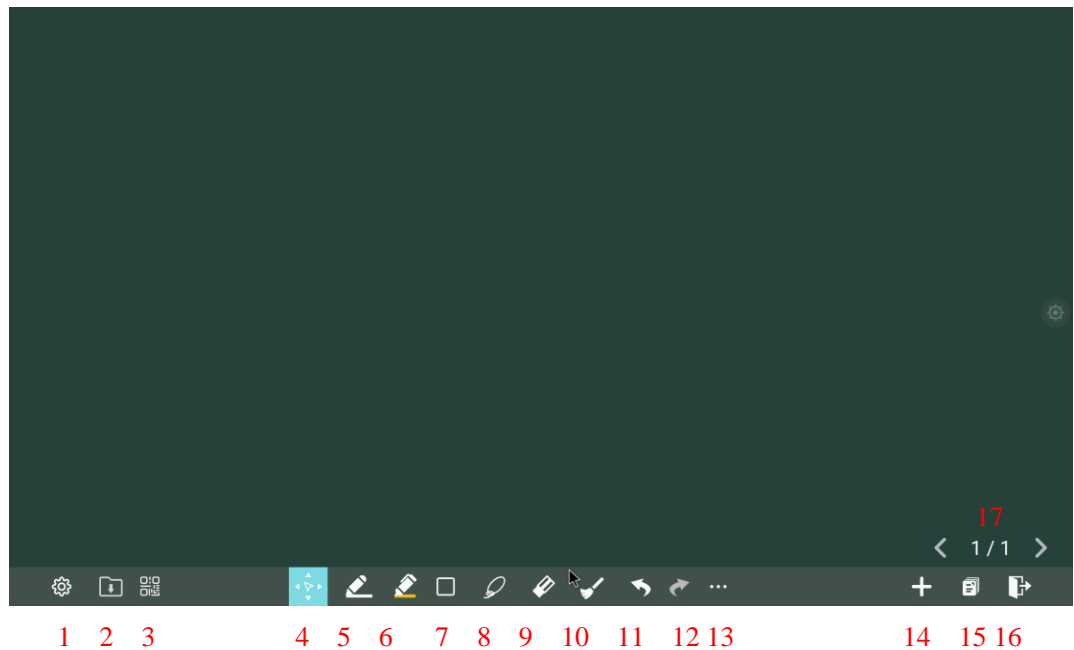

SN	Icon Name	Icon Function
1	Settings	Tap to enter the setting interface.
2	Whiteboard Files	Tap to enter files interface. Users can open the whiteboard files, insert the files, or save files etc.
3	QR code exporting	Tap to export the whiteboard data into QR Code.
4	Move Canvas	Tap and move in the page to move canvas and content on it.
5	Pen	Tap to use the pen function, and the icon turns into blue. Tap to set the pen type, size or color. And the chosen color and the size would be shown by the icon.
6	Highlighter	Tap to use the highlighter function, and the icon turns into blue. Tap to set the size or color and adjust the transparency. And the chosen color and the size would be shown by the icon.
7	Auto shape	Tap to insert the auto shape. Tap to set the shapes and color.
8	Select	Tap to select and edit the whiteboard content. When the object is selected, users can move, zoom in/out, copy, cut, rotate, lock, change layer or delete object.
9	Eraser	Tap to select the eraser function, tap to set the way of eraser.
10	Clear	Clear all data in this page.
11	Undo	Back to the previous step.
12	Next	Turn to the next step.
13	Option	Tap to import data, insert image, Text, Sticky note, Search Image or Search Web etc.
14	New Page	Tap to add a new page.
15	Background	Tap to set the pattern and the color of new page.
16	Exit	Tap to exit the whiteboard mode.
17	Page navigation	< Tap to return to the previous page. > Tap to go to the next page. 1/1 Tap to show the page thumbnails.

4.4.1.1 Whiteboard function

New Page and Settings

- Create a new page

On the whiteboard, tap  to create a new page. Up to 20 pages can be created. As shown in the following figure.

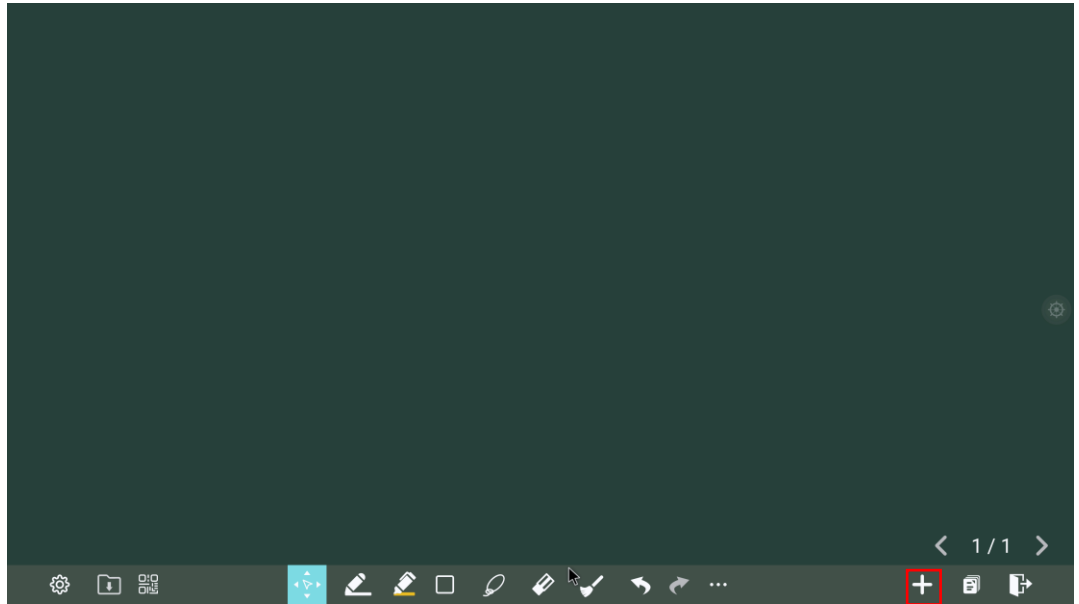

- Page settings

Tap  to set the color and pattern of a new page, as shown in the figure below.

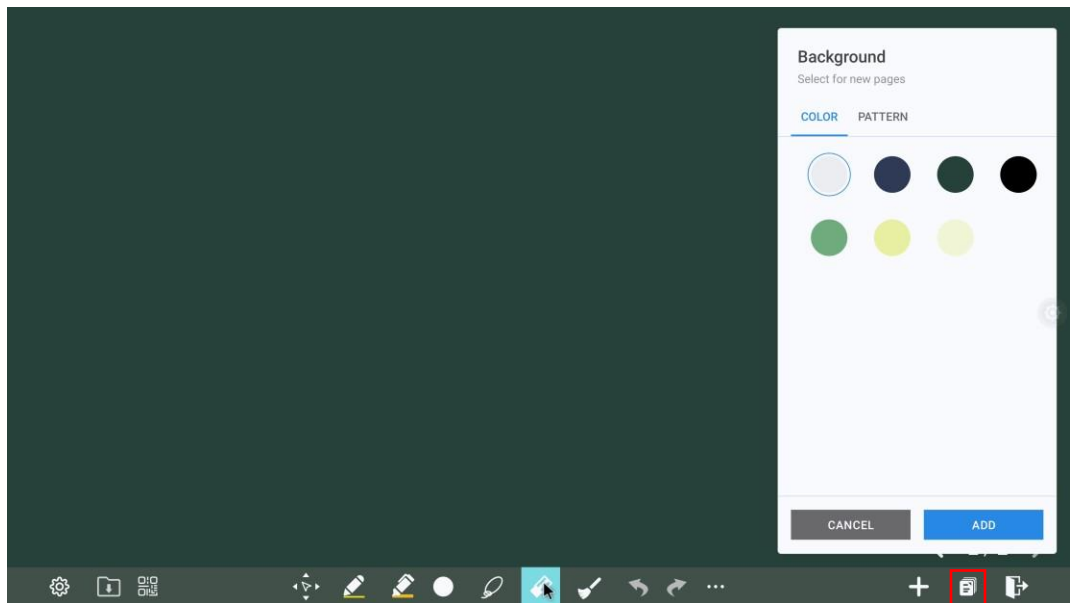

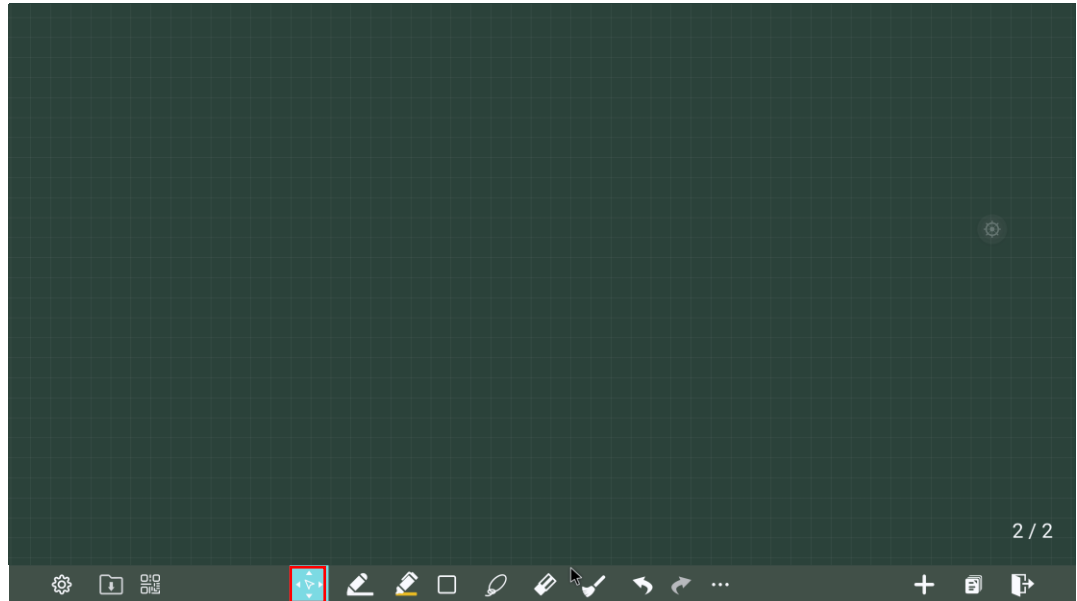

Move canvas

On the whiteboard, tap the  icon to enter move canvas function, press and move your finger in the page to move canvas and content on it.







Pen Type

On the Whiteboard, two types of pens are supported: pen and Highlighter.

- Pen  : used to write and draw.
- Highlighter  : used to highlight. Characters covered by comments are still visible.

Line Size and Color

On the Whiteboard, tap  to set the pen type, size and color. You can select the pen type, line size and color for writing, as shown in the following figure:

-  : Hard pen, used to write, the content can be cleaned by eraser;
-  : Word recognition pen, writing content will be automatically recognized as text;
-  : Shape recognition pen, writing content will be automatically recognized into shape.

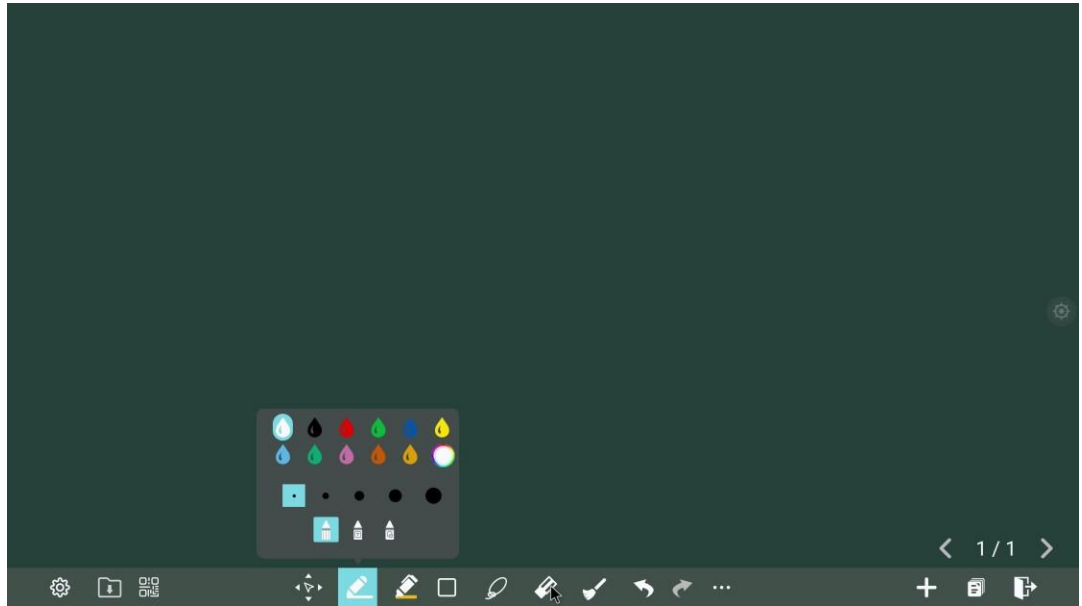

Insert auto shape

On the Whiteboard, tap  to insert the auto shape, you can also change the shapes and color.

Shapes: Circular, ellipse, square, equilateral triangle, right triangle, star, arrow, line

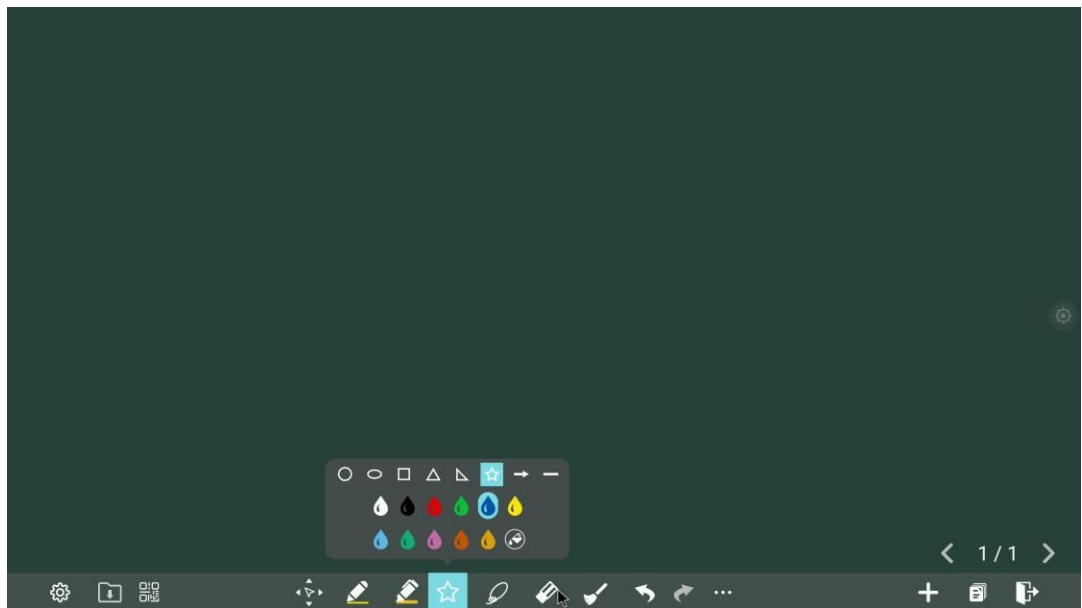

The  icon status are represented by three colors, gray for not available, white for shape outlines, and shape fill when it turns blue.



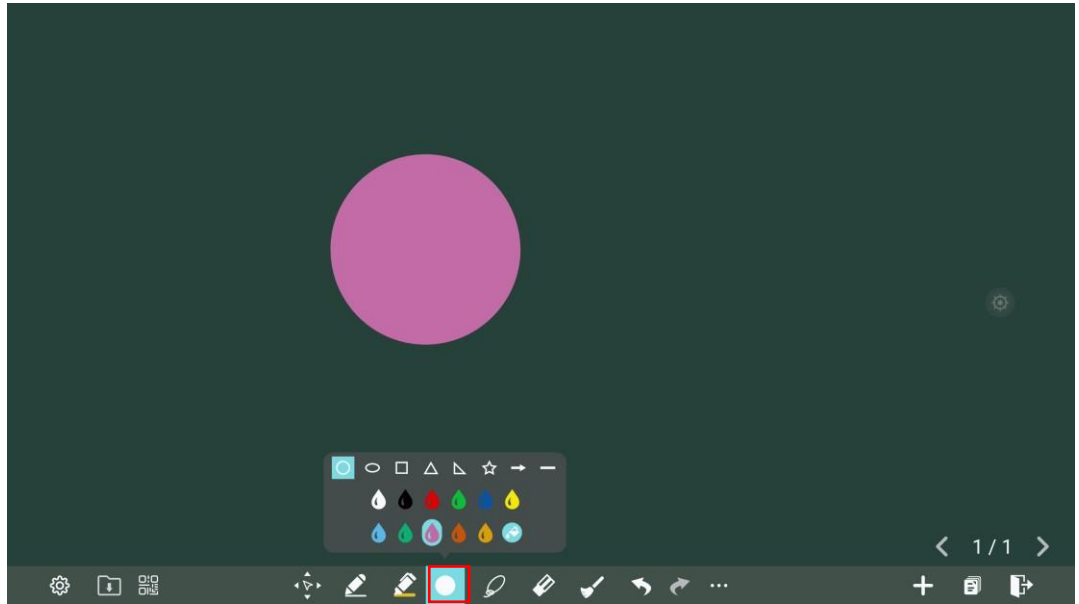



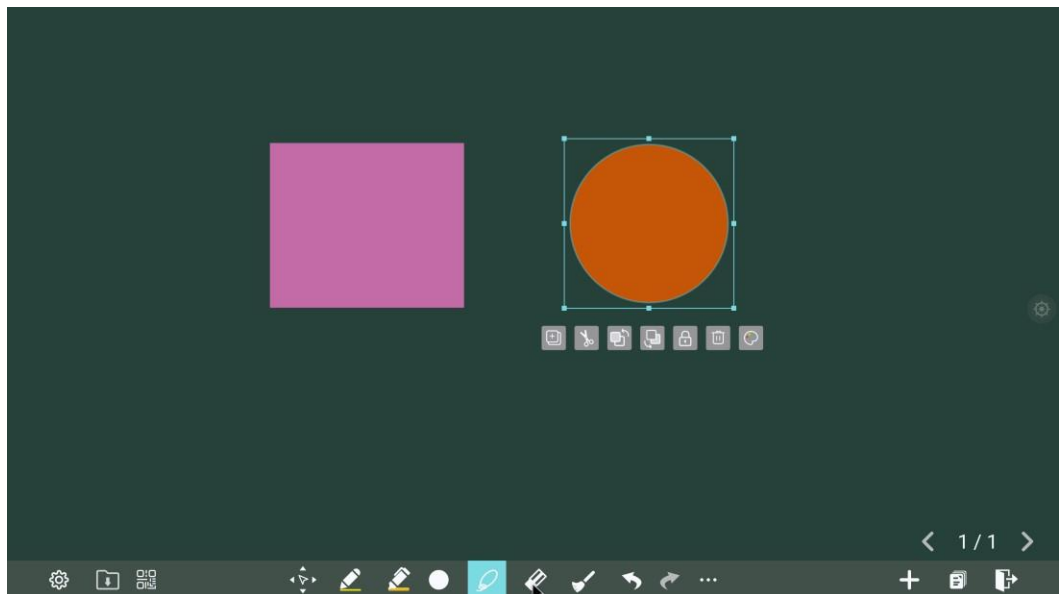

- Gray: The icon is unavailable when users insert arrow and line;
- White: The edge of shapes are colored;
- Blue: The shape will be filled with colors when you import the shape;



Selected



On the Whiteboard, tap  and user could choose the data or sharp on the page to move/ zoom in/ zoom out/ rotate by two fingers, and the icon turns into blue.



Icon	Functions
	Tap this icon to copy the items.
	Tap this icon to cut the items.
	Tap this icon to push to top layer.
	Tap this icon to push to bottom layer.
	Tap this icon to lock the layer.
	Tap this icon to delete the items.
	Tap this icon to change the color.
	Paste (Long press the screen around two seconds. The icon will appear only after one object copied or cut)
	Tap this icon to unlock the layer. (The icon will appear only after one object locked)

Eraser

On the Whiteboard, tap  to clear wrong or unnecessary content. Two methods are available to erase written errors or content as follows:

- Partial eraser: Tap  to clear the passing part of eraser.
- Object eraser: Tap  to clear the whole object.

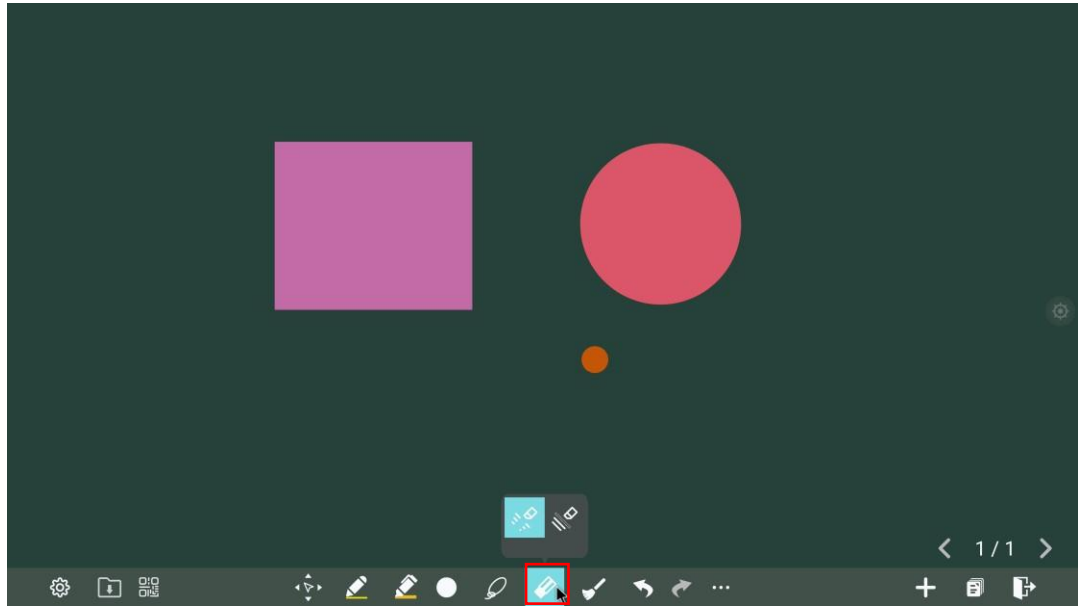

Clear All

On the whiteboard page, tap  to show the pop-up windows to make users choose if they want to clear contents on the current page, as shown in the following figure.

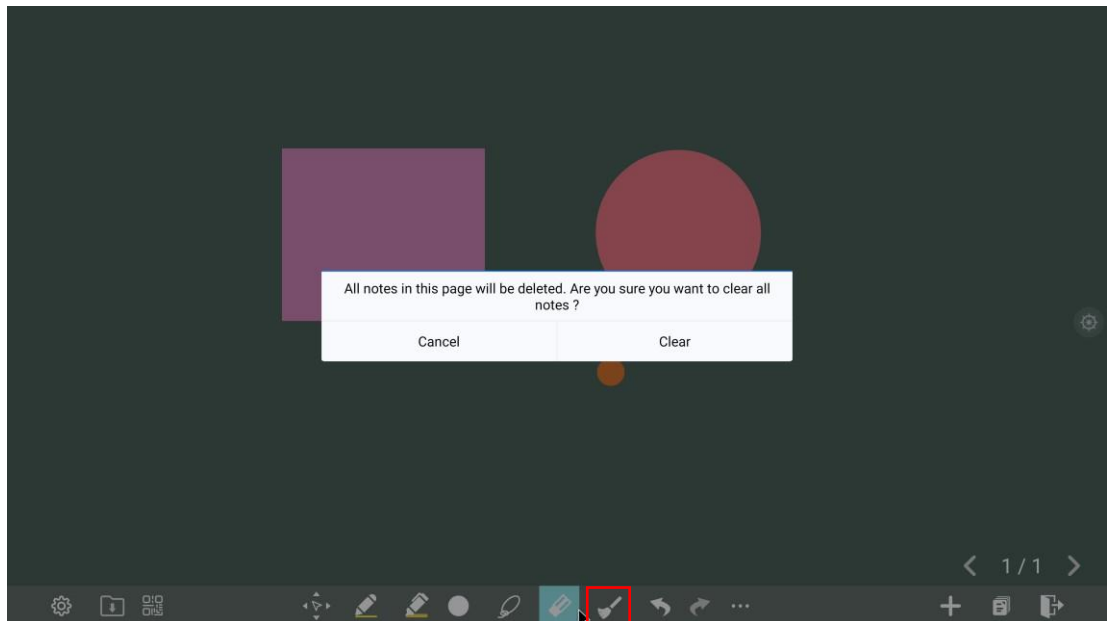

Options

Under the **Options** menu are some small functions and tools, which are composed of add, tool and canvas. Tap the  icon to enter options interface.

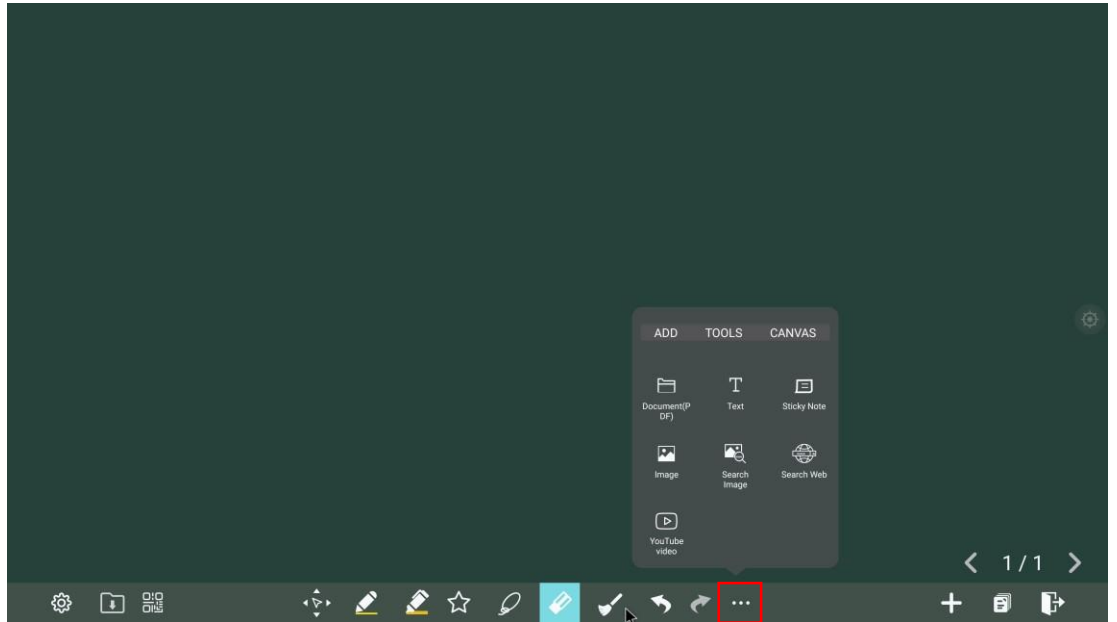

- On the **ADD** items, you can import the pictures, Text, Sticky note, PDF document from system files, USB, network. You also can import the Search Image or Search Web on the internet.

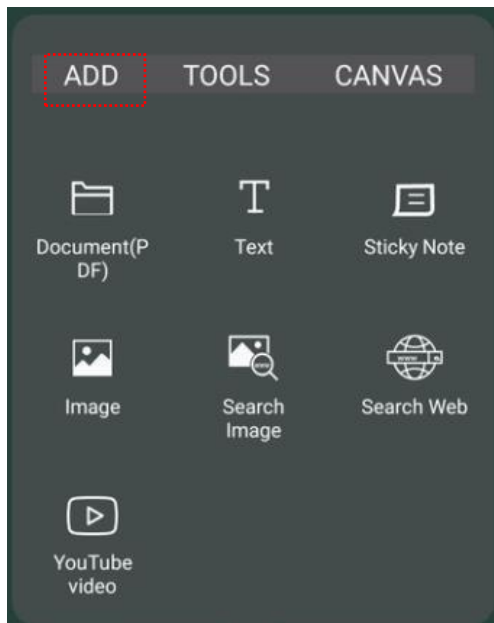

- On the **TOOLS** items, you can use rulers to draw line or shape on the page, import the visualizer image etc.

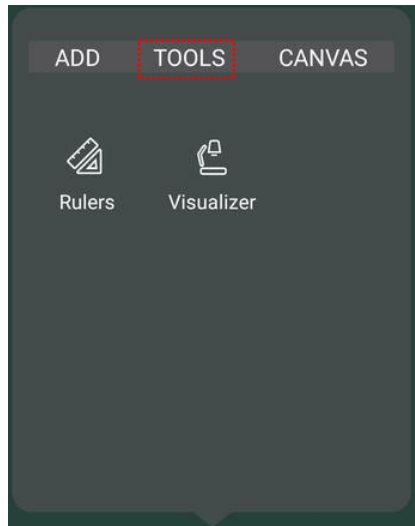

- On the **CANVAS** items, you can choose split mode to set the split application, enter the recorder and take a screenshot.

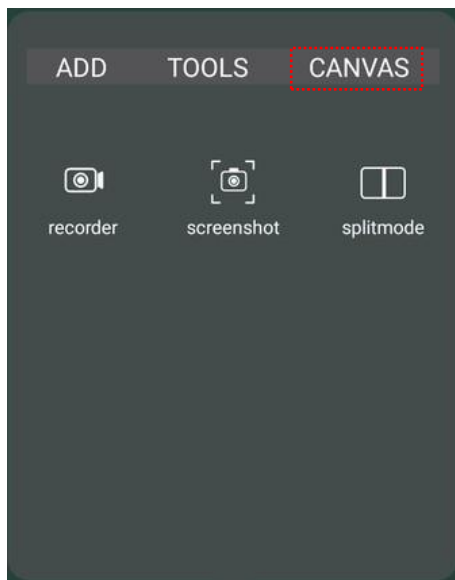

Files

On the **FILE** items, you can import whiteboard files from file management, save whiteboard files and export whiteboard page.

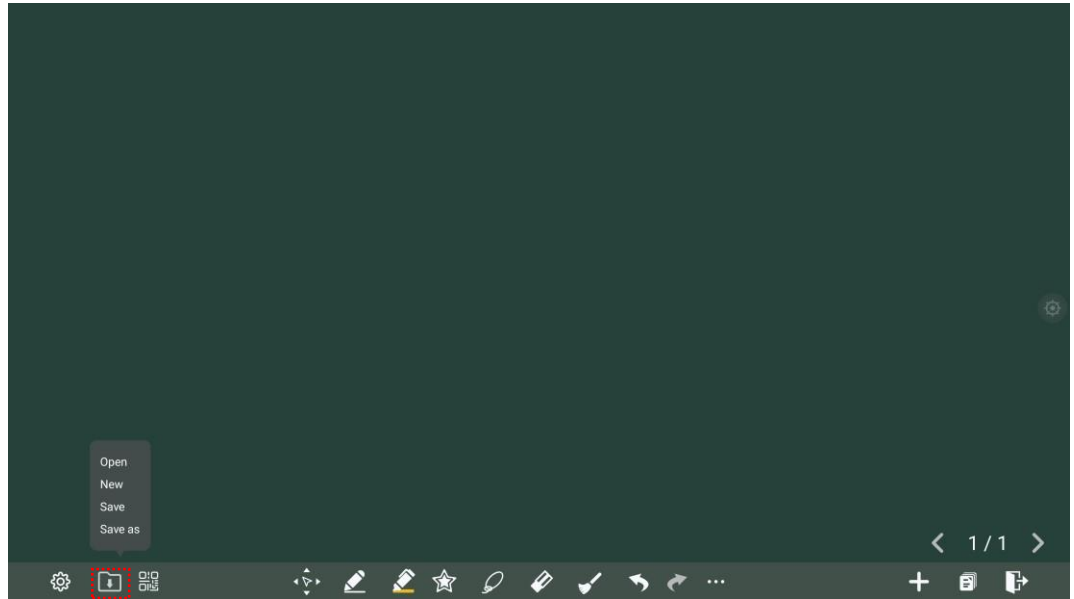

QR code export

On the Whiteboard, tap  to pop up QR code exporting windows. You can export the whiteboard page into QR Code, before that, you can customize the number of export page, change the export format at first.

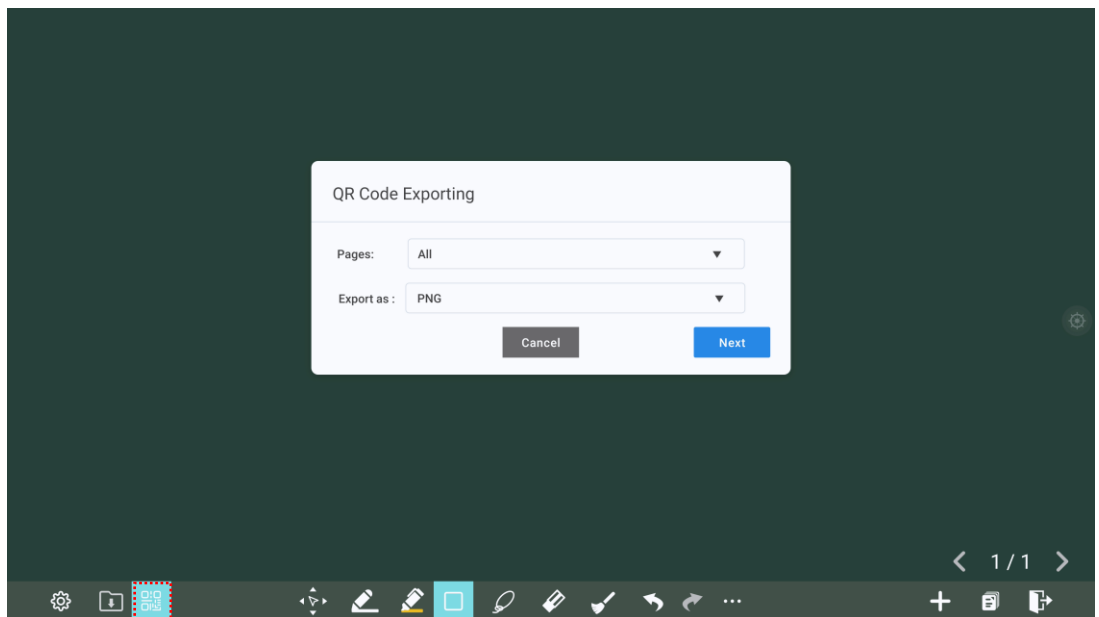

4.4.1.2 Page Operations

You can preview, select, save, export and delete a created writing page.

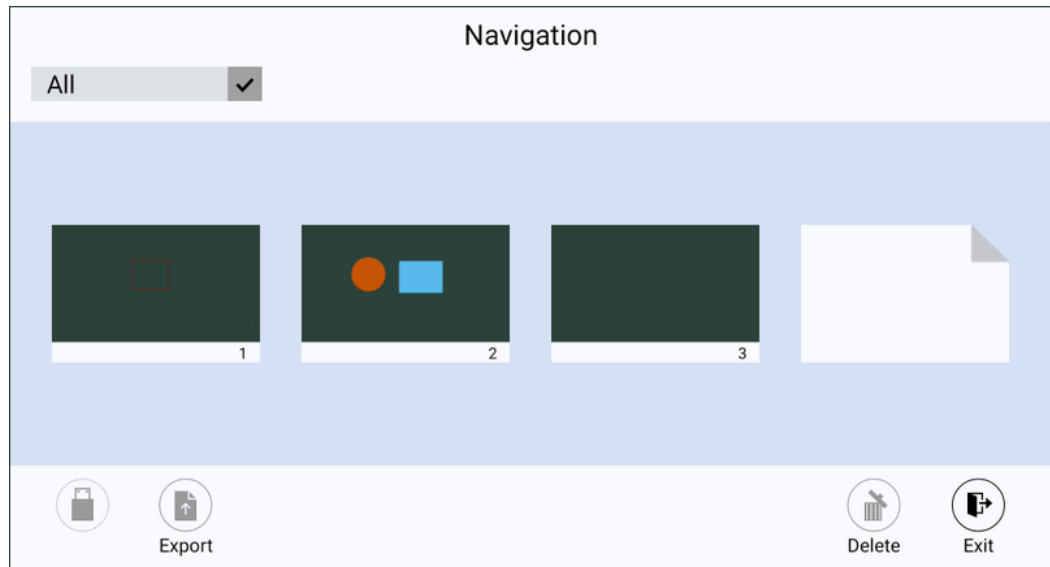

Page Preview

Tap 1/1 at the lower right corner in the discussion mode. All pages will be displayed, you can slide right or left by one finger to see more, as shown in the following figure.



Page Selection

On the **Navigation** page, you can select, export or delete writing pages according to requirements, as shown in the following figure.

- Tap  to select all pages.
- Tap  to save the pages to USB flash device.
- Tap  to export selected pages.
- Tap  to delete selected pages.
- Tap  to exit the page.

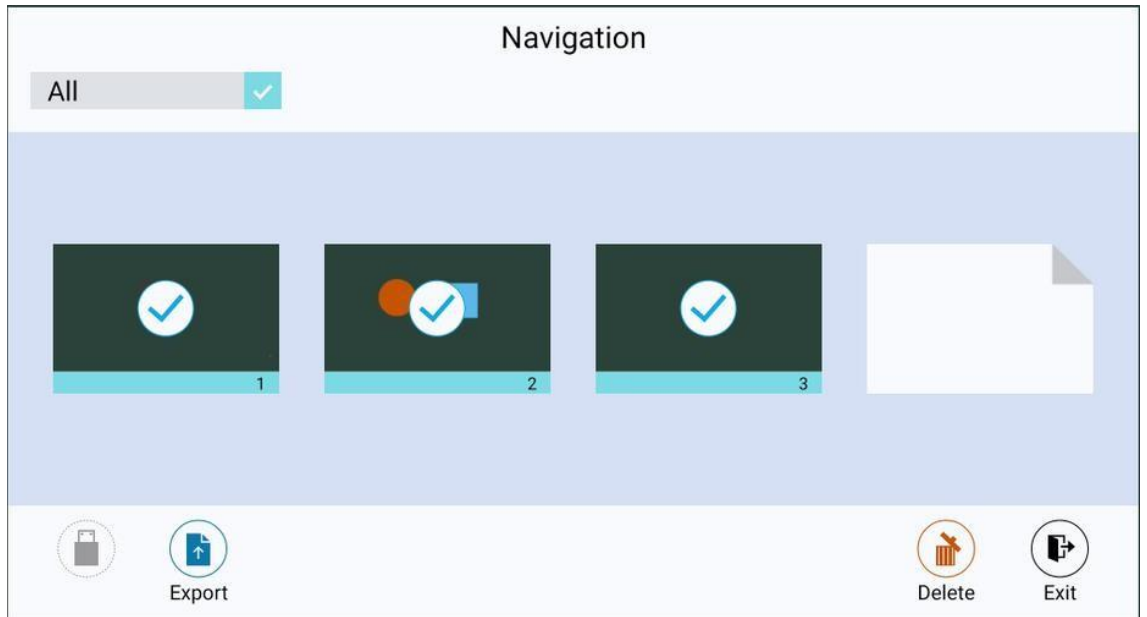

Page Saving

On the **Navigation** page, when no external USB flash memories are connected, USB icons will be gray. When an external USB flash memory is connected, USB icons will turn into yellow. Tap the USB icons and the selected whiteboard file can be saved in the folder of "Screenshots" under the root directory of storage device.

NOTE

- Do not eject USB flash memory before completing the saving process.
- If the USB flash memory is larger than 16GB or the file format is not FAT32, the data will not be saved properly.

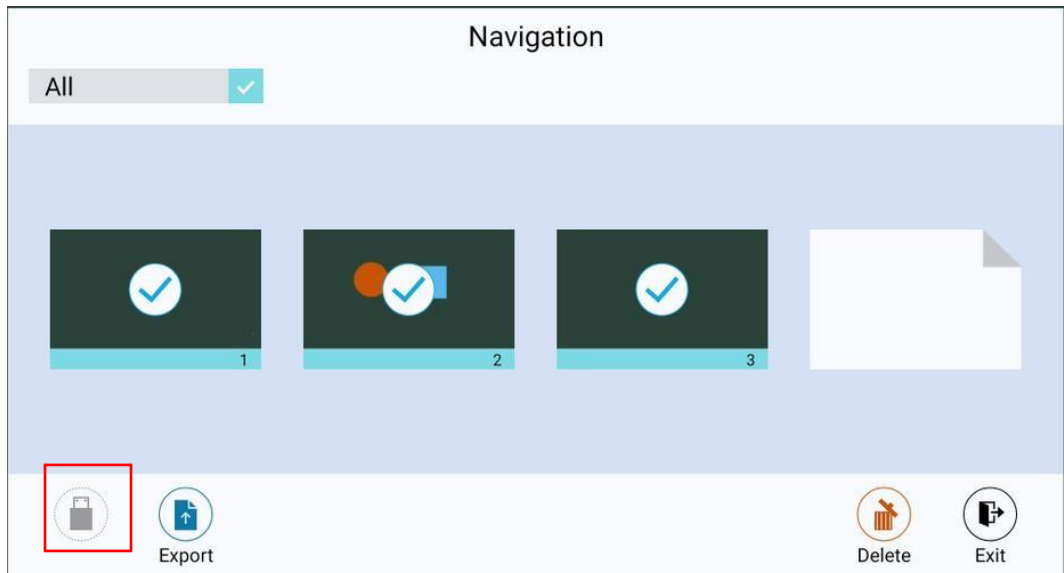

Page Exporting

Step 1 On the **Navigation** page, tap  icon to pop up exporting window.

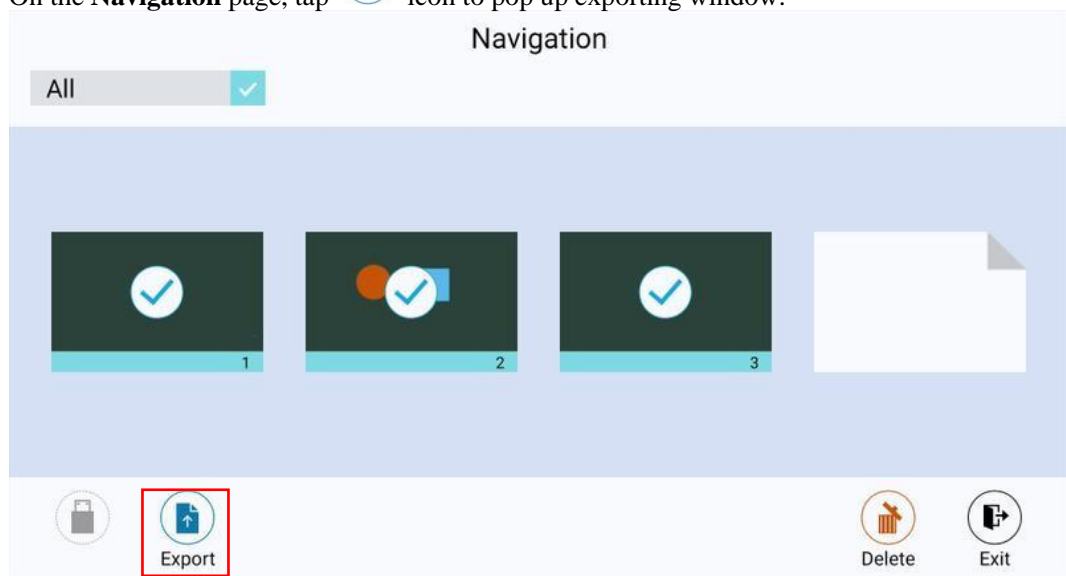

Step 2 You need to select the export format (png, jpg or pdf), tap Next.

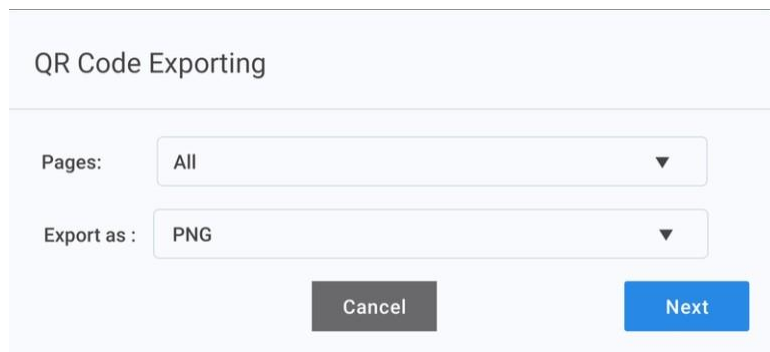

Step 3 The selected whiteboard page will be exported into QR Code, you can scan the QR code to download the file.

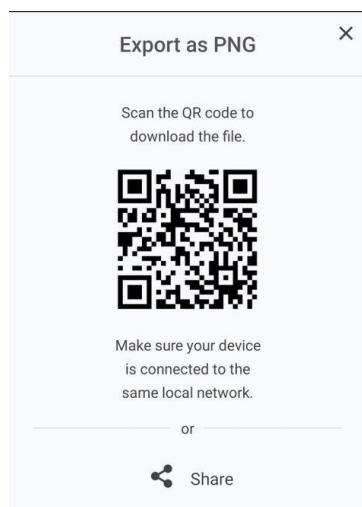

Step 4 Tapping share to save screenshot to pictures, save with FC or aqua mail.



4.4.1.3 Whiteboard Setting

Tap the  icon to enter the settings bar, users can set the object recognition, action hint and default settings.

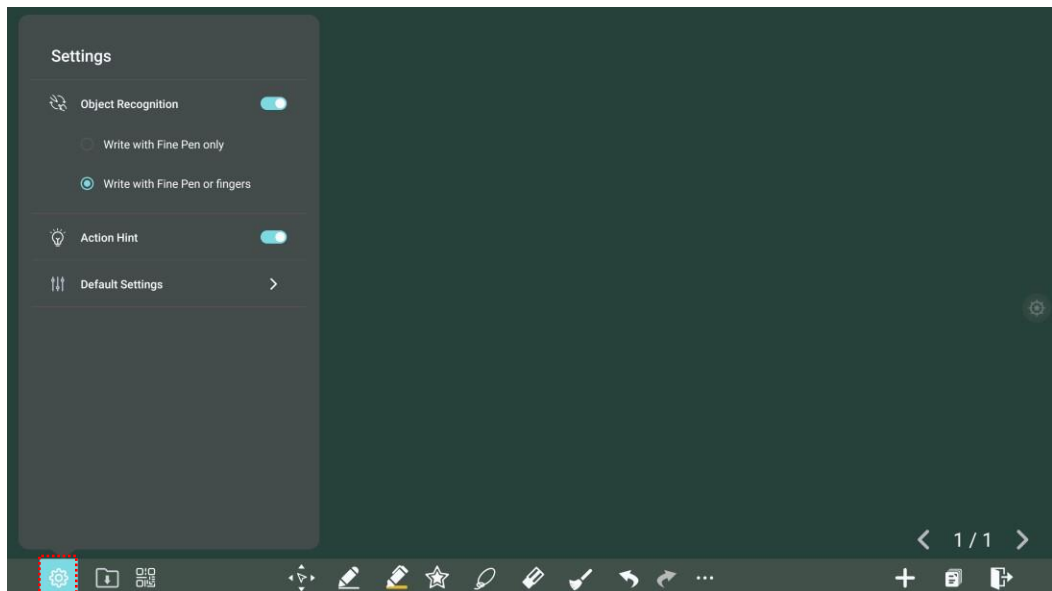

Object recognition

Users can drag the slider to enable the object detection function

1 Turn on write with Fine Pen only

- Fine Pen (2mm): User Fine Pen to write and erase with small eraser.
- Fist/Palm: Identified as an eraser (100 pt).
- Tap: Select an object without switching to grab tool.
- Drag: Move objects or canvas.
- Pinch with two fingers: Zoom in/out selected objects or canvas.
- Rotate with two fingers: Rotate selected objects.

2 Turn on write with Fine Pen or fingers

- Fine Pen and finger (thick pen): User Fine Pen or finger (thick pen) to write. System will detect the thickness of writing and automatically switch to the corresponding color and thickness of pen/highlighter.
- The move button: After tapping this button, you can move the canvas with one finger or pen, and zoom in/out with two fingers (pinch).
- Palm/Fist: Erase with big eraser.
- Long press on objects: Shortcut for selecting objects.

3 Turn off object recognition

- Switch manually: Tap each function you want to use manually every time.
- The move button: After tapping this button, you can move the canvas with one finger or pen, and zoom in/out with two fingers (pinch).
- Long press on objects: Shortcut for selecting objects.

Action hint: Drag the slider to enable the action hint.

Default settings: Tap the button to enter default setting page, users can set whiteboard page background, change the color and thickness of Smooth Pen and Highlighter, change the default type of eraser, both object eraser and partial eraser can be set.

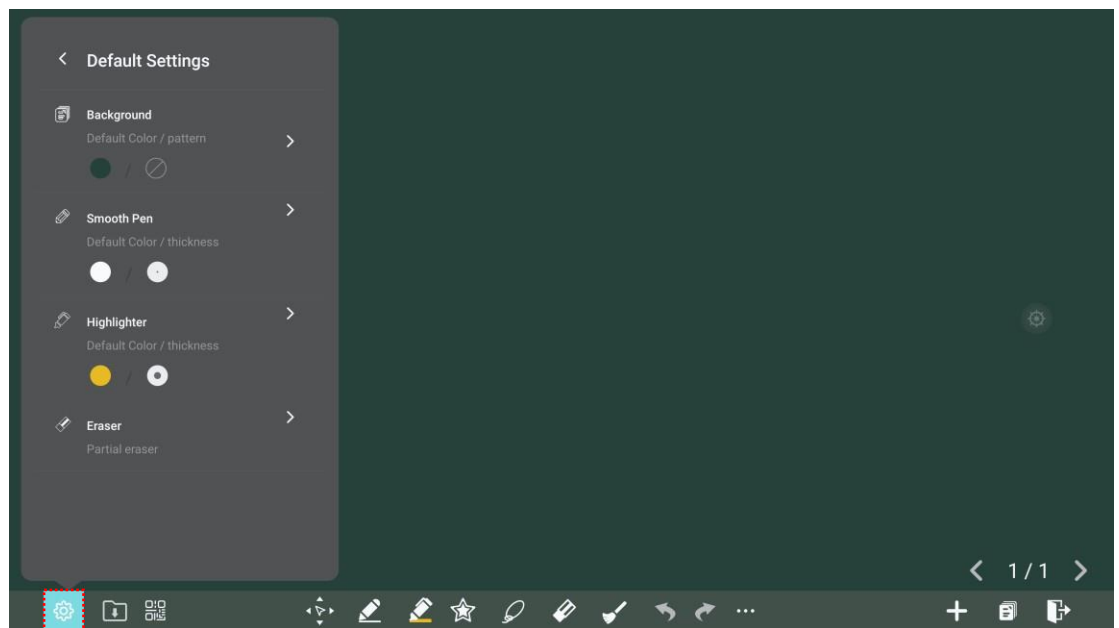

4.4.2 Annotation

Tap  in the floating toolbar to enter the annotation. In the annotation mode it would generate a transparent layer above the screen, and users can add the annotation on it until they exit the annotation mode.

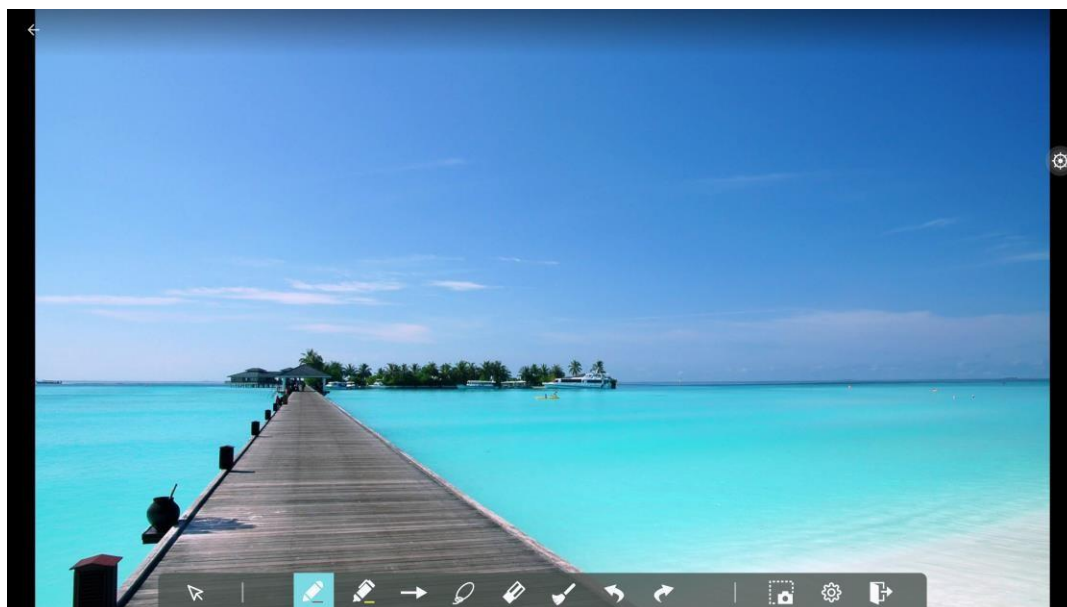

1 2 3 4 5 6 7 8 9 10 11 12

SN	Icon Name	Icon Function
1	Cursor	Tap to return to the current interface from the annotation mode to control the application or interface. When the function is selected, the annotation part is still on the screen.
2	Pen	Tap to use the pen function, and the icon turns into blue. Tap to set the size or color. And the chosen color and the size would be shown by the icon.
3	Highlighter	Tap to use the highlighter function, and the icon turns into blue. Tap to set the size or color. And the chosen color and size would be shown by the icon.
4	Auto shape	Tap to insert the auto shape. More details refer to Insert auto shape of whiteboard section.
5	Select	Tap it and user could choose the data on the page to move/ zoom in/ zoom out/ rotate by two fingers, and the icon turns into blue.
6	Eraser	Tap to select the eraser function, when it is selected, the icon turns into blue.
7	Clear	Clear all data in this page.
8	Undo	Back to the previous step.
9	Next	Turn to the next step.
10	Screenshot	Tap to take a screen shot, and save the picture to the file management.
11	Object recognition switch	Tap to change the object recognition setting, slide to left to open the object recognition function, slide to right to turn it off.

SN	Icon Name	Icon Function
12	Exit	Tap to exit the annotation mode.

Screenshot

In the annotation mode, tap  to save the current image as a picture. Up to 50 screenshots can be created.

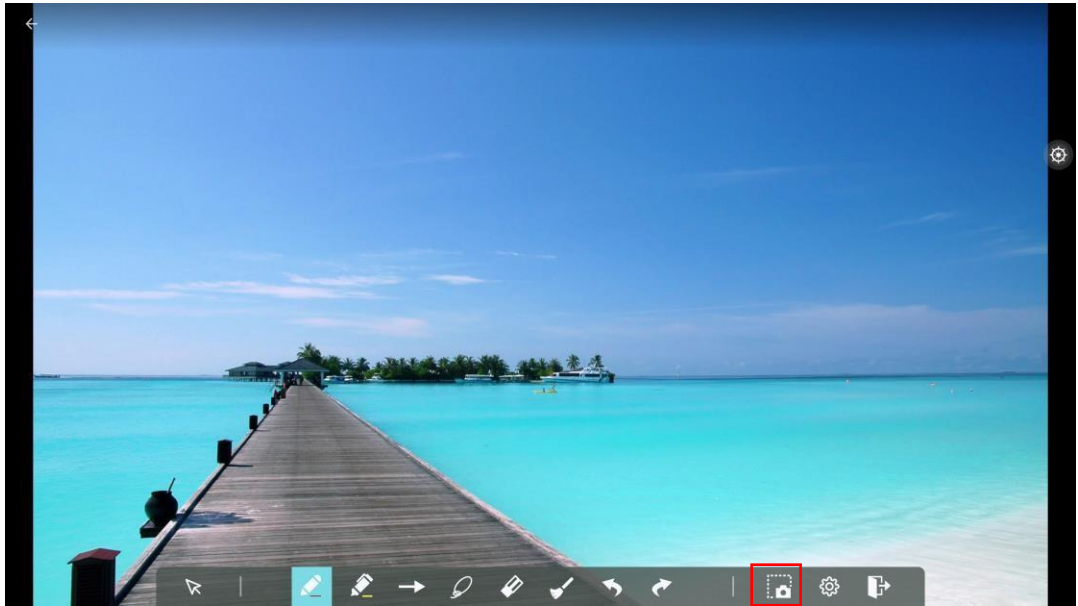

On the Home page, tap **File Management** icon, select "**Internal storage > Pictures > Screenshots > image**" folder to view or get screenshots.

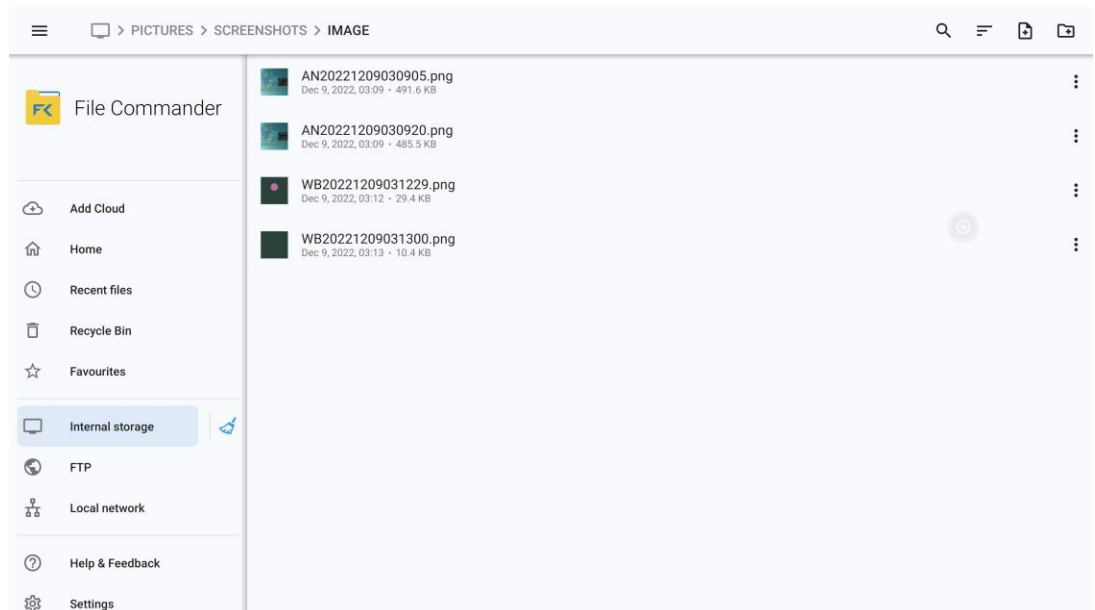

4.4.3 File Management

The product supports connection to USB flash memory. In File Viewer application, you can preview all files in the internal storage and storage devices connected via USB ports and move, copy, paste, delete and search for files.

File Preview



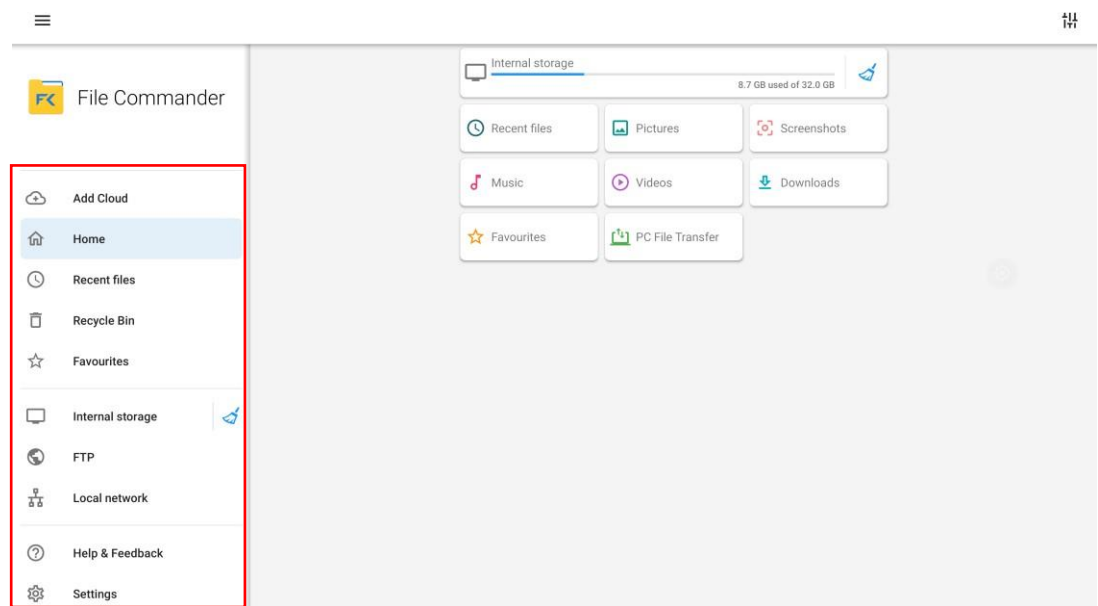



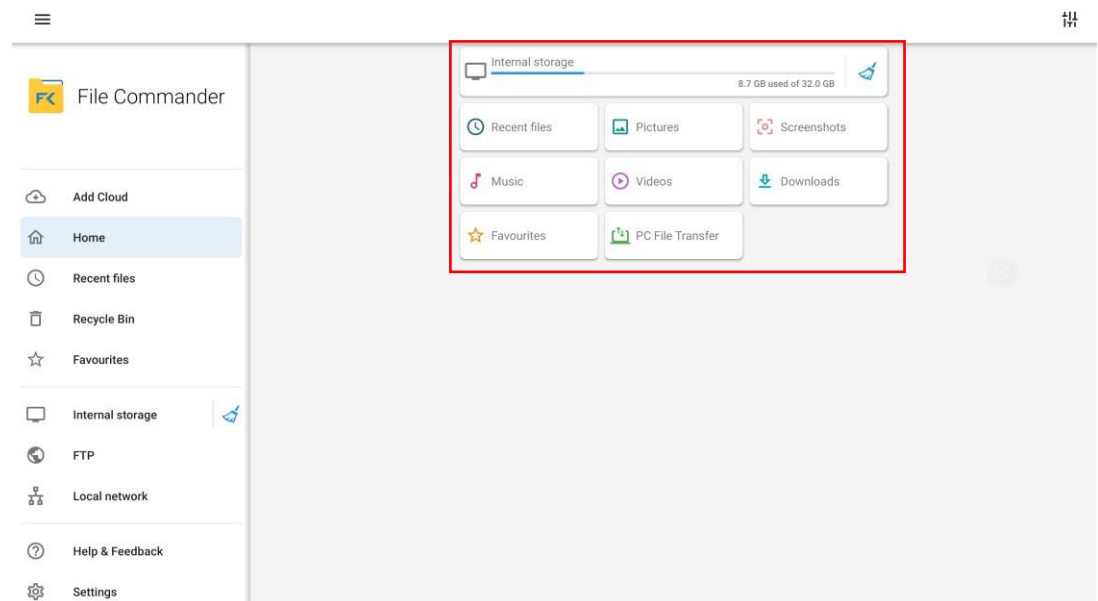





Using the File Viewer application, you can tap the submenu in the left navigation panel to preview what files are on internal storage, external storage devices connected via the USB ports, cloud stored files, FTP uploaded files, and local network files, as shown in the following figure.



Tap the submenu on the right to preview internal storage, recent files, pictures, screenshots, music, videos, downloads, favorites, PC file transfer, tap the icon to view the files.



Icons on the top of right corner:

Icons	function
	Tap to search the files by files name.
	<ul style="list-style-type: none"> The system supports two view modes: list and grid. You can tap  on the top right corner to switch  or  view modes. Tap  to display files based on name, type, size, and modification.
	Tap to create new file.
	Tap to create new folder.
	Tap to paste the selected image.
	Tap to delete the selected image.
	Tap to cut the image.
	Tap to copy the image.
	Tap to move the image to other files.

File Operation

Enter the File Viewer application. You can create folders according to requirements, select files by long pressing, and set wallpaper/copy/paste/delete. For details on other operation, tap  in the upper right corner for more operation.

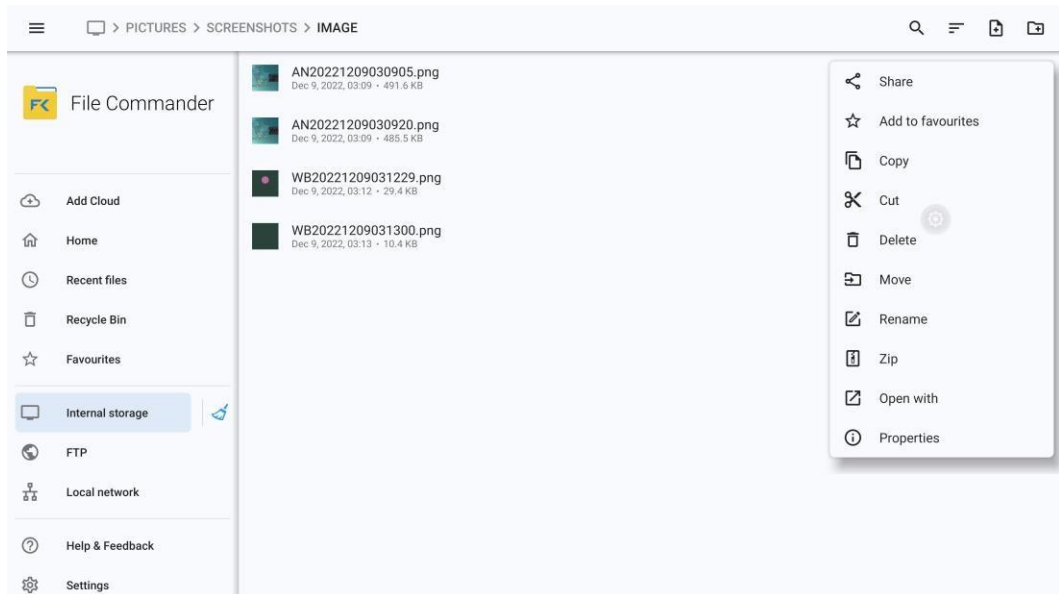

File Name

Under the "Internal storage > Screenshot " folder in the File Manager, remote control screenshots of this meeting are saved.

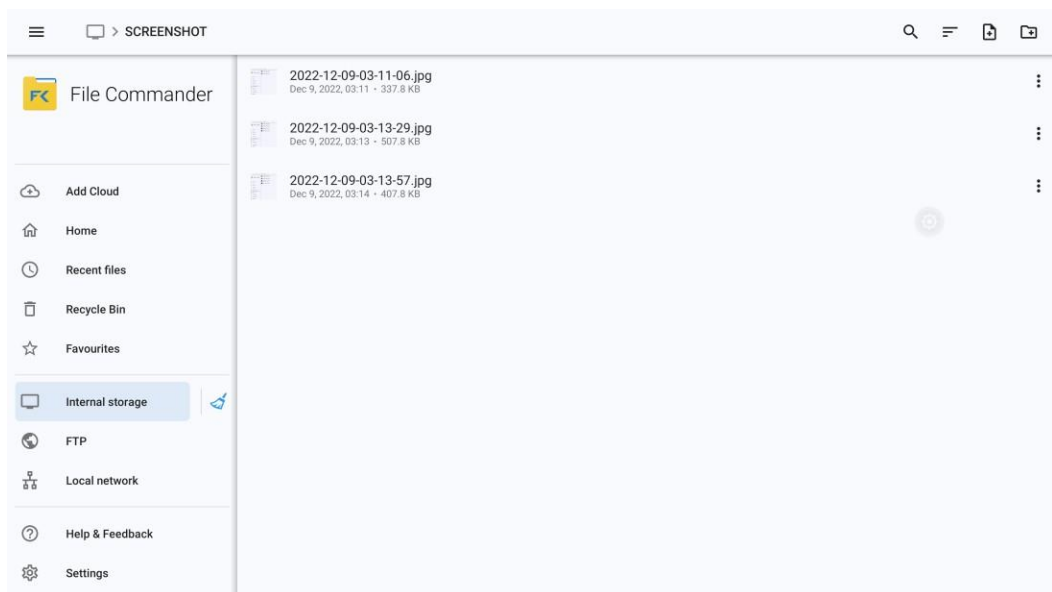

Under the "Internal storage > Pictures > Screenshots" folder in the File Manager, annotation page screenshots and discussion screenshots are saved.

Depending on the screenshots mode, picture naming is different. Picture files are named in the following of prefix + creation file.

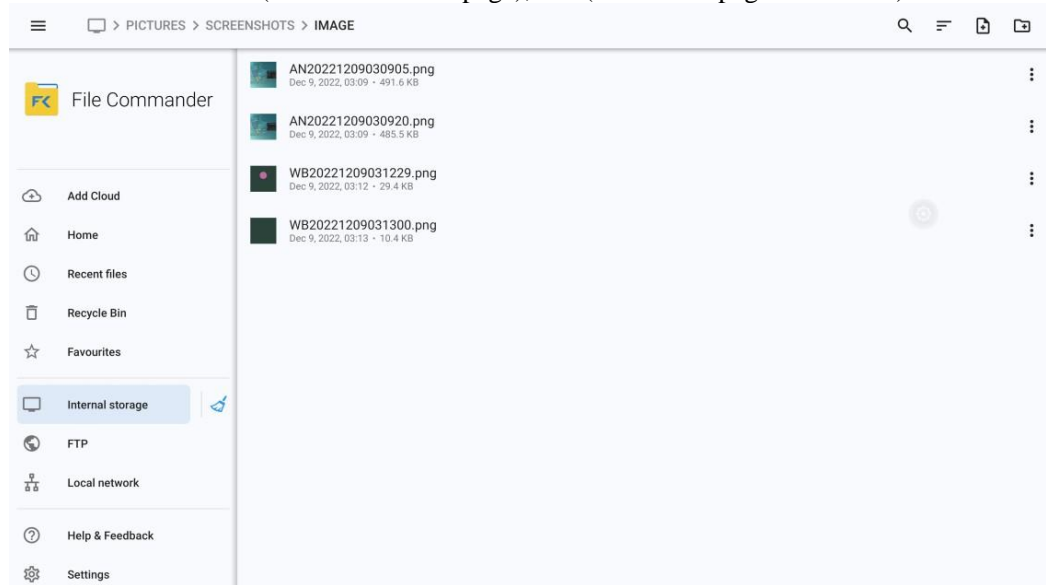

Prefix name rule: WB (discussion mode page), AN (annotation page screenshot).





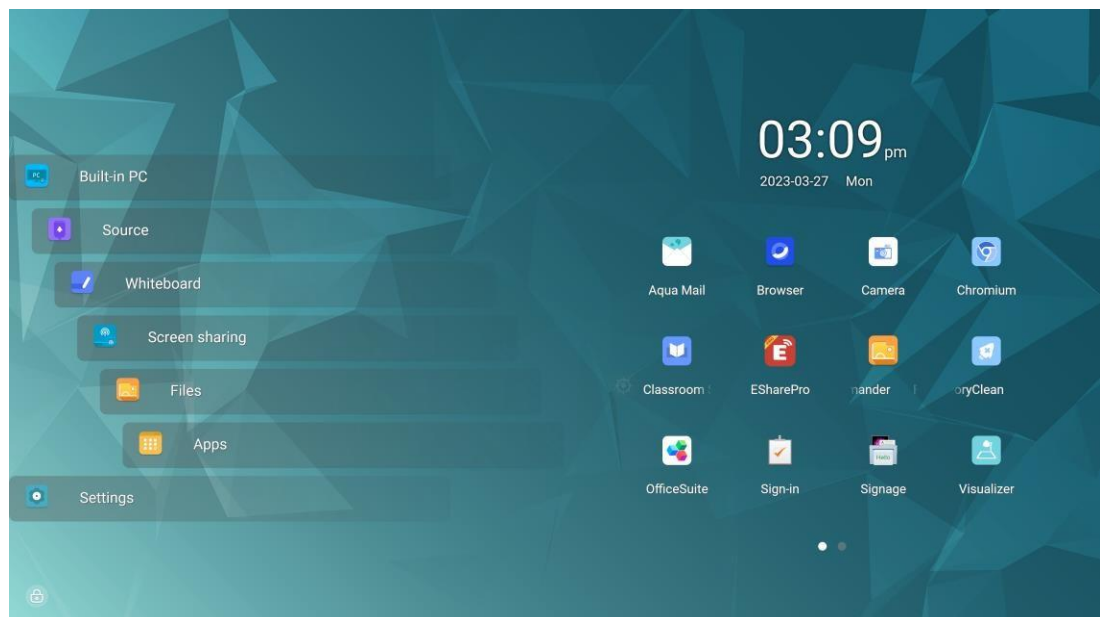







4.4.4 Application program

On the Home page, tap **App**. On the page that is displayed, all applications can be viewed. The following figure shows applications that the system is delivered with.



Name	Icon	Functions
Aqual mail		Tap this icon to enter the email application and send files. Before sending files, you need to add an email account.
Browser		Tap this icon to enter the browser application.

Name	Icon	Functions
Camera		Tap this icon to access the camera application
Chromium		Tap this icon to enter the chromium application.
Classroom Share		Tap this icon to enter the Classroom Share application
Eshare Pro		Tap this icon to enter the Eshare pro application
File Commander		Tap this icon to open the File Manager and you can explore all internal and external files on the screen.
Memory Usage		Tap this icon to enter the Memory Usage application.
Office suite		Tap this icon to enter the Office suite application. In this application, you can view office files, including excel, word, power point, and PDF files.
Sign-In		Tap this icon to enter the Sign-In application
Signage		Tap this icon to enter the Signage application.
Vote		Tap this icon to enter the Vote application
Visualizer		Tap this icon to enter the visualizer application.

Camera

Tap the “” icon on the Application program to enter “Camera”, you can select camera mode or video mode, when taking a video, audio will automatically be recorded.

Swipe right to access the menu for the picture or video taking, you can swipe to view, share or delete your data.

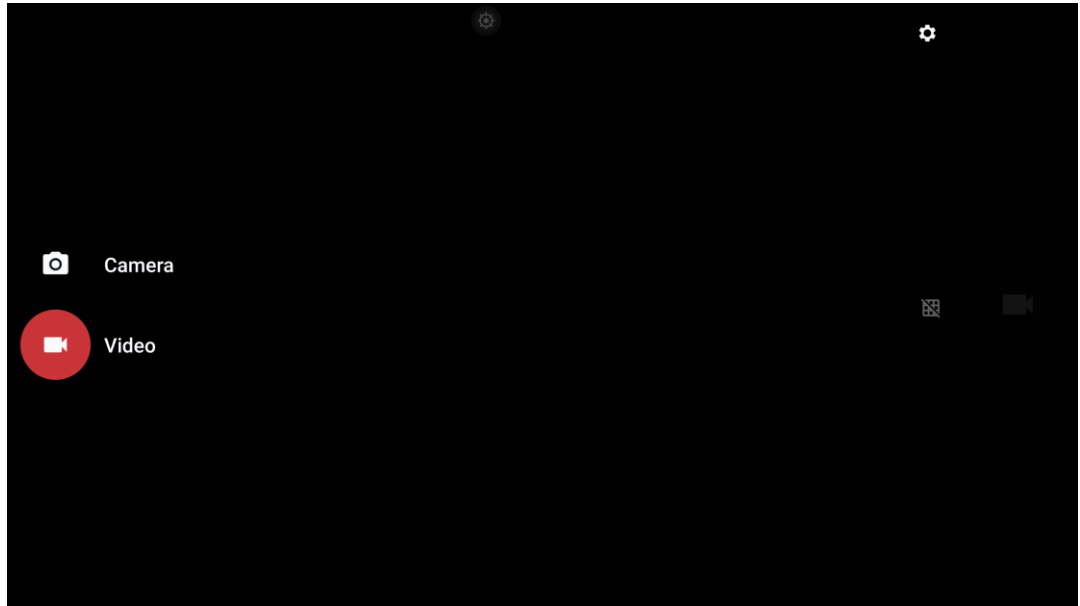

 **NOTE**

- Video recording cannot be used at the same time as Screen Recording. If Screen recording is already activated, video recording will not be turned on.
- Image and video took by Camera will be saved in: File Commander > DCIM > Camera.

Sign-In

Users can be acquired by scanning with third party QR scanner software under your mobile device. After the participants have signed in, the relevant information is synchronized to the sign-in form in real-time:

Tap the “” icon on the Application program to enter the “**Sign In**”, scan the QR code with your mobile devices. Your devices will be directed to a website for you to input your name, company name, and department name.

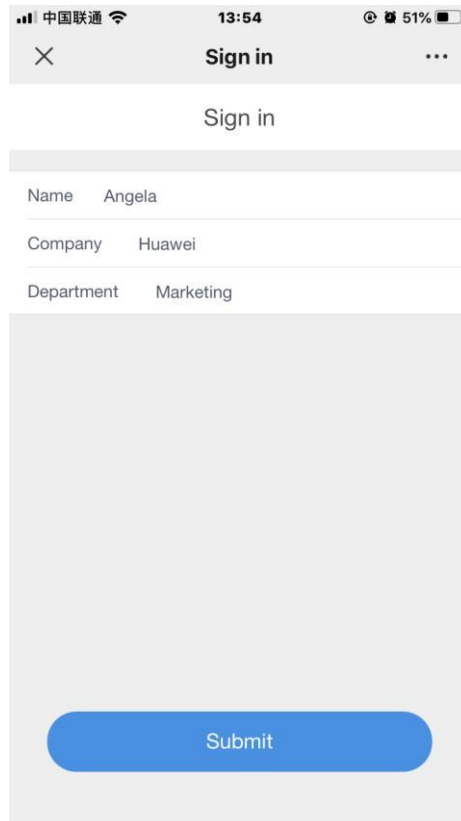

 **NOTE**

“Sign In” only works when both the panel and the mobile device are connected to the internet.

After the user tap submits from their mobile devices, their input will be shown on the Sign-in list. The meeting host can tap **“Complete”** to finish the signing process.

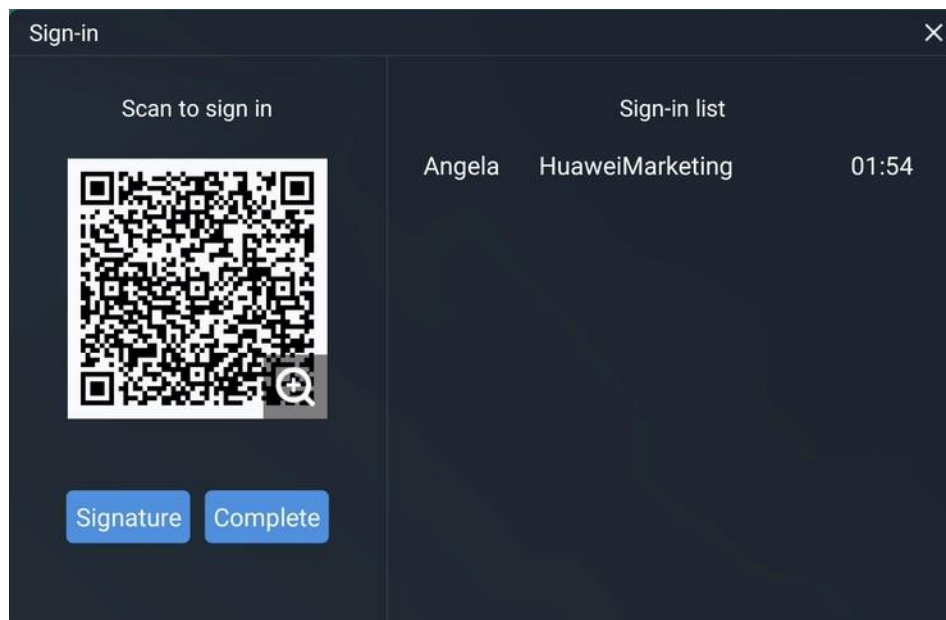

After the meeting host tap **“Complete”**, users can use their mobile device to scan the QR code to download the Sign-in List onto their mobile devices.

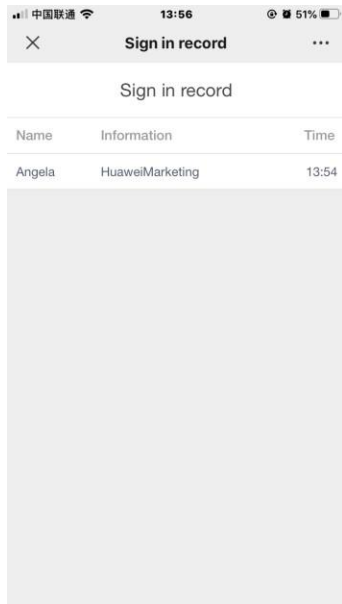
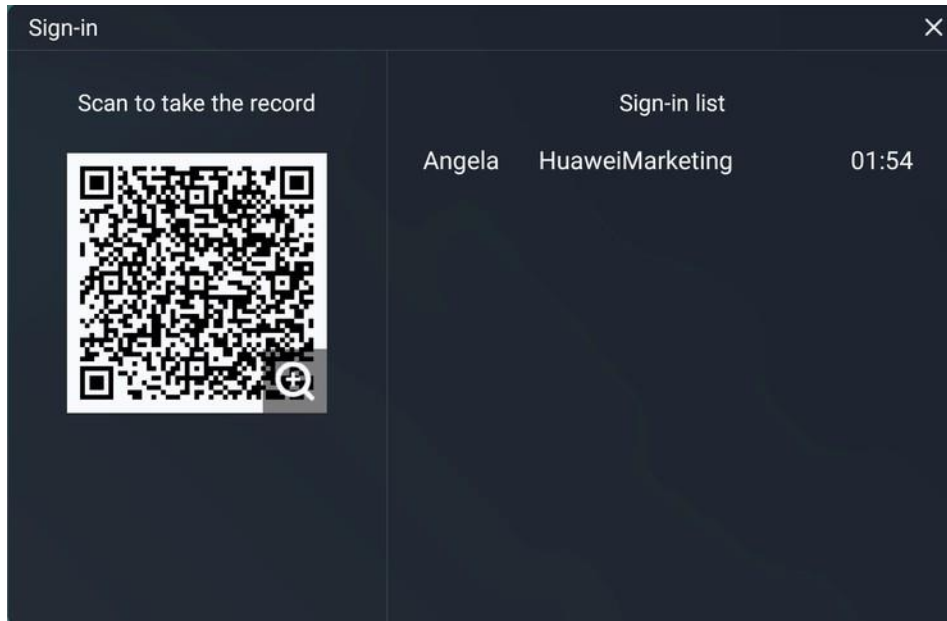

The user can also select the “**Signature**” button to enter the signature interface. Handwritten sign-in can be done by hand or with a stylus. The bottom toolbar includes a pen, an eraser and background settings (customization), etc. The sign-in interface can be saved by scanning the QR code. The user can tap the “” button in the lower right corner to exit the sign-in interface.

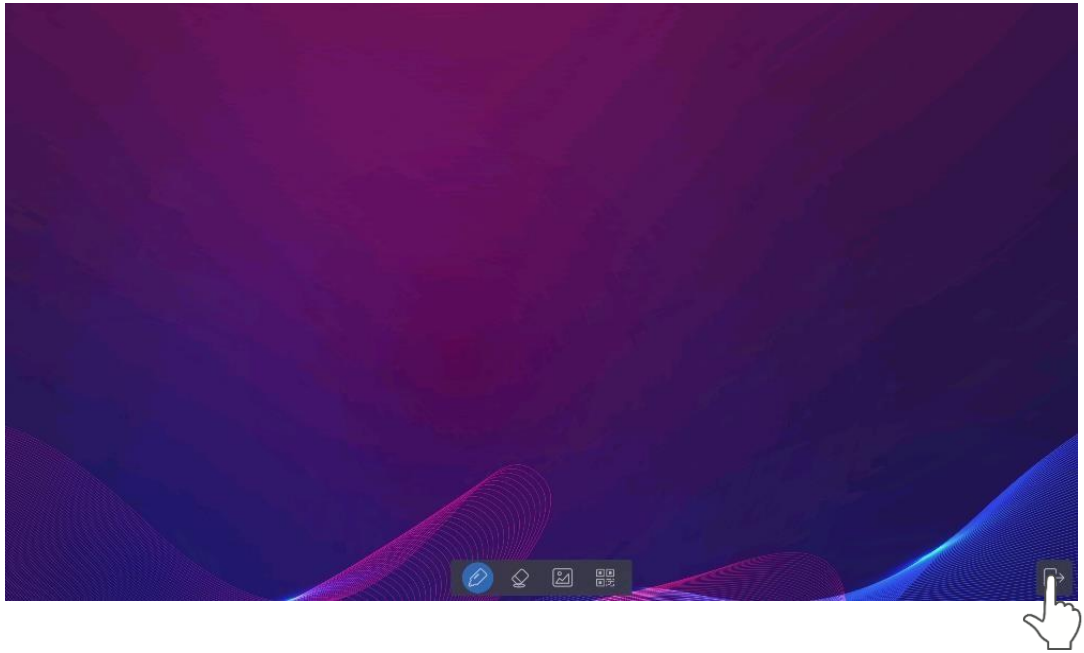

NOTE

If the user is idle for more than 8 seconds on the signature interface, the bottom toolbar will be automatically hidden. The users can tap the hidden button at the bottom to call out the toolbar again.

Vote

Tap the  icon on the Application program to enter “**Vote**”:

Users can input a topic (not required) and input options (2 options minimum, 10 options maximum). After tapping “**Complete**”, a QR code is generated for users to scan with their mobile devices.

A screenshot of a mobile application screen titled "Ballot Settings". The screen has a dark background. At the top, there is a text input field with the placeholder "Topic(optional) Company Retreat Destination". Below this, there is a list of five options, each with a label (A through E) and a text input field: A Paris, B Tokyo, C Bali Island, D Ko Samui, and E Cash Instead. Each option has a minus sign icon to its right. Below the list, there are two radio buttons: "Single/Multiple" with "Single" selected and "Multiple" unselected. At the bottom center, there is a blue button labeled "Complete".

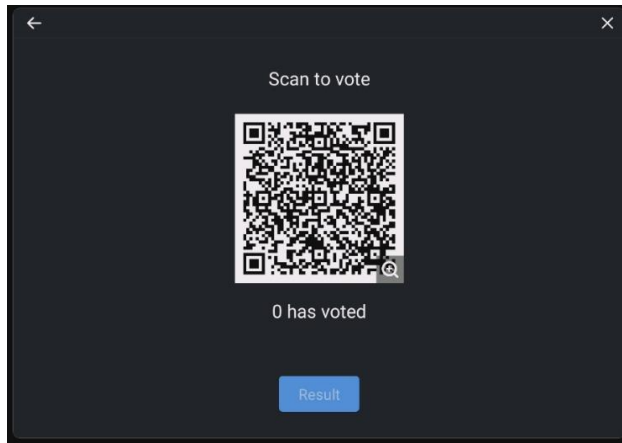

 **NOTE**

“Vote” only works when both the panel and the mobile device are connected to the internet.

User will see the voting topic and options on the mobile device after the QR code is scanned. After making the selection, tap “submit” to cast vote.

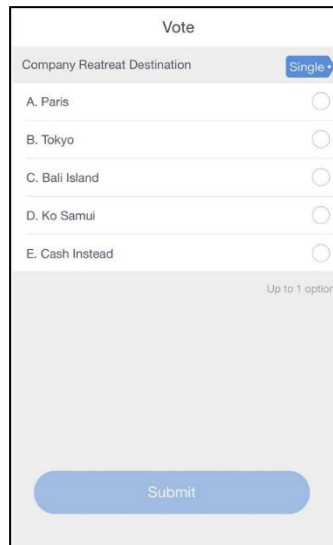

In the voting process, the number of voters is displayed in real-time under the QR code.

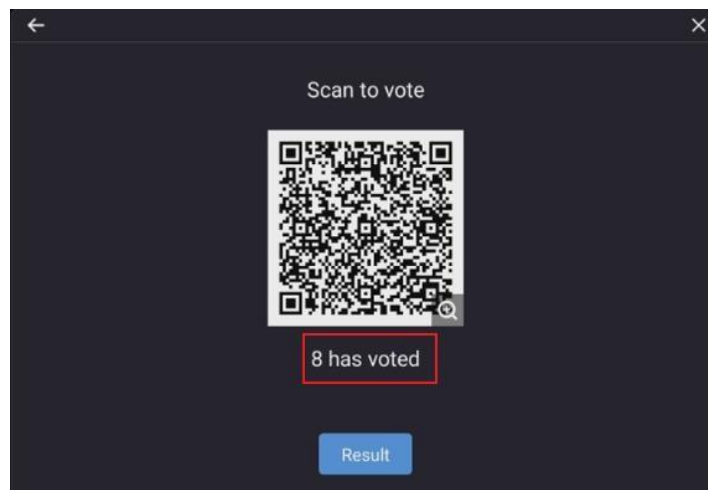

The user can tap the “Result” button to terminate the current vote process and show the voting results.

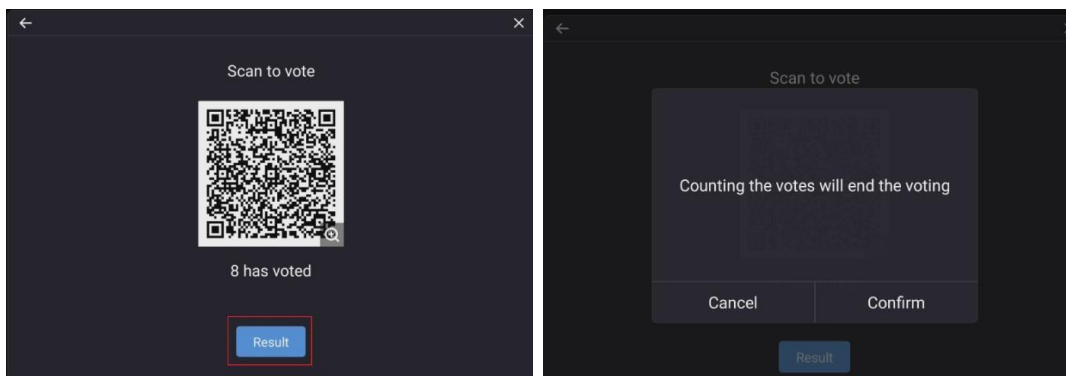

The voting results can be displayed in the “Pie chart” or “Bar chart” form.

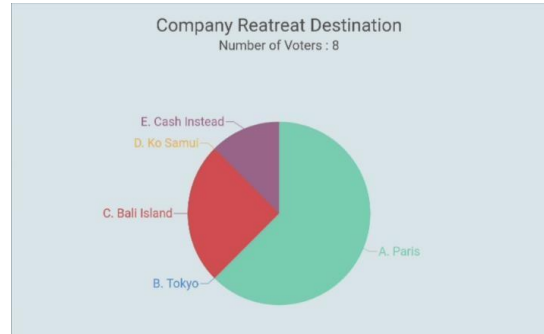

The user can tap **Insert into whiteboard** to insert the current voting results into the whiteboard.

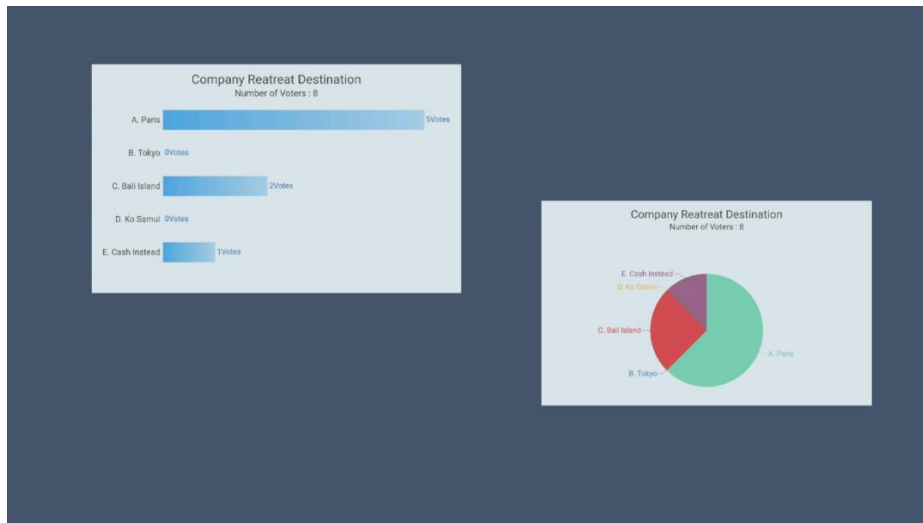

Classroom Share

Tap the “” icon on the Application program to enter the **Classroom Share**. Tap **enter** to bring up the classroom tools.

Students can scan the QR code and input name to join in the classroom share.

popover on the panel

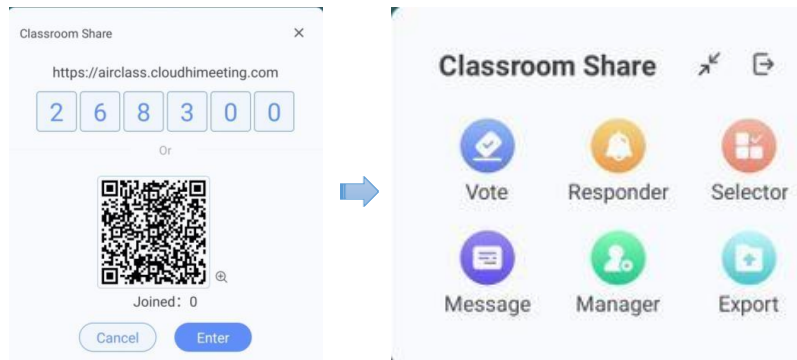

popover on the mobile device

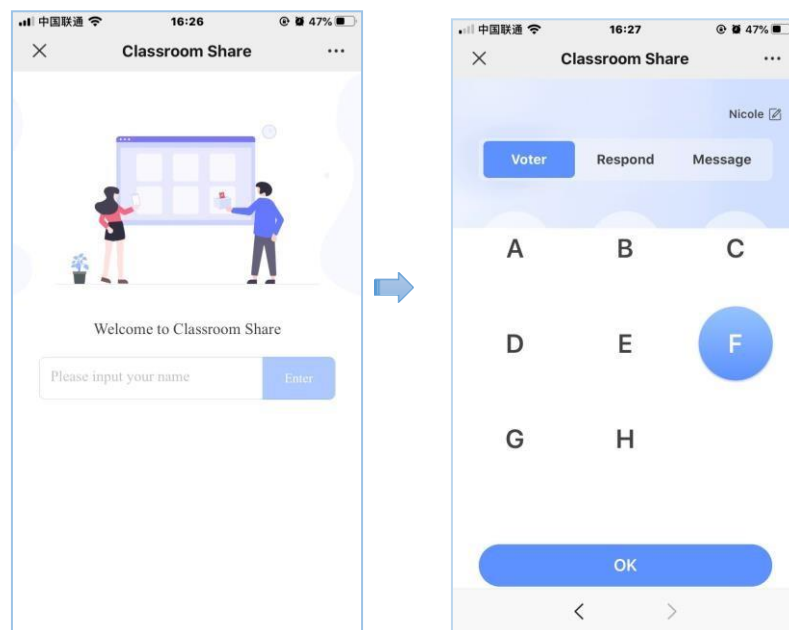

Vote

Step 1 Tap **vote** to create a new vote, input vote topic (not required) and input options (2 options minimum).

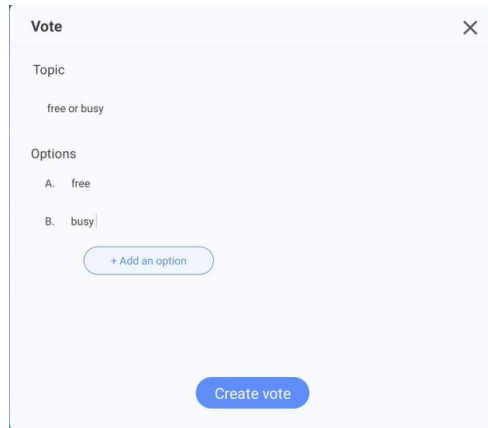

Step 2 Tap **create vote** and students can vote on the mobile device. The proportion of votes will real-time display on the screen;

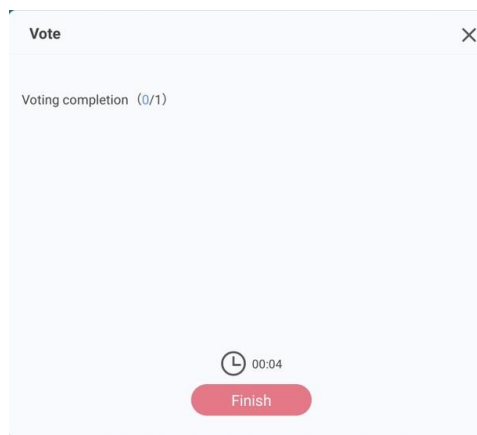

Step 3 Tap **finish** to check the vote result, Bar charts and pie charts are supported for showing voting results.

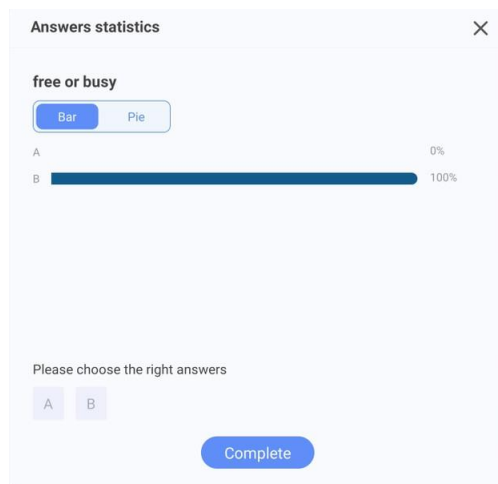

Responder

Tap "**Responder**" on the panel to create a responder, the "**Responder**" button on the mobile device will be available. Tap the button on the mobile phone, the name of the first successful student will be displayed on the panel.

Selector

Tap "**Selector**" button on the panel to initiate the selector, select the number of students to win, tap "start", the system will conduct a random selector from the list of students who have joined in the classroom share. After the selector is complete, winner's name will be displayed on the panel.

Message

Students input message on the mobile device and click Send. When the panel's bullet screen is on, the bullet screen message will appear on the screen. The color of the bullet screen can be customized.

Manager

Tap "**Manager**" button to view the joined information.

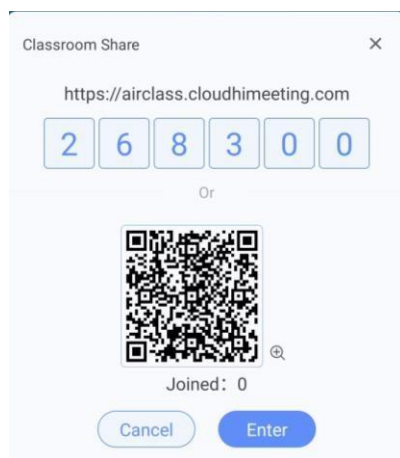

Export

Tap "**Export**" button to save the classroom share data to file management.

Signage

Tap the  icon on the Application program to enter the **Signage**. In this page, the user can select the desired template style and customize welcome words under "**Default**" or "**Save File**" mode, as shown below:

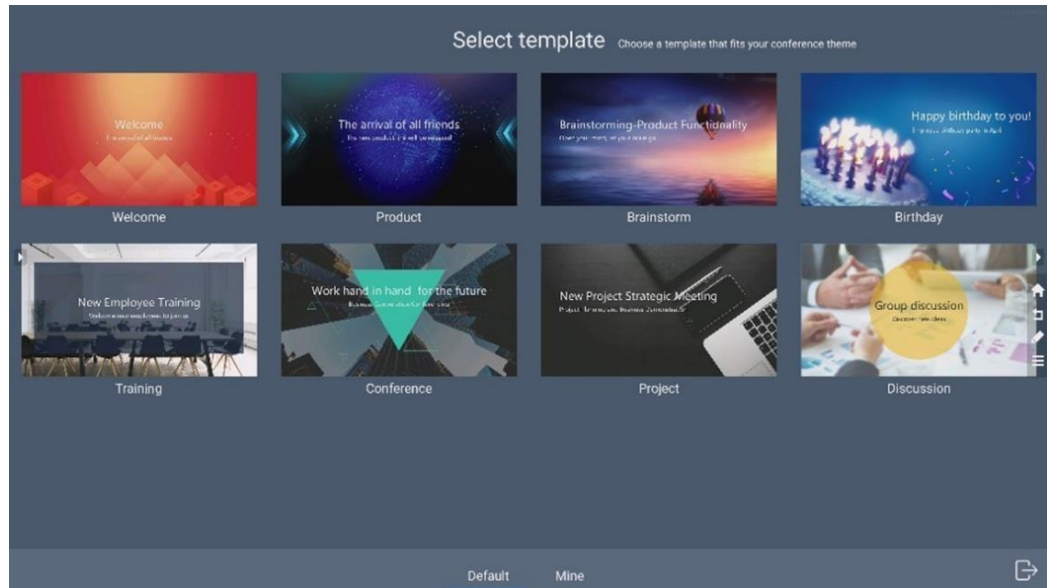

After selecting a template, enter the template editing interface:

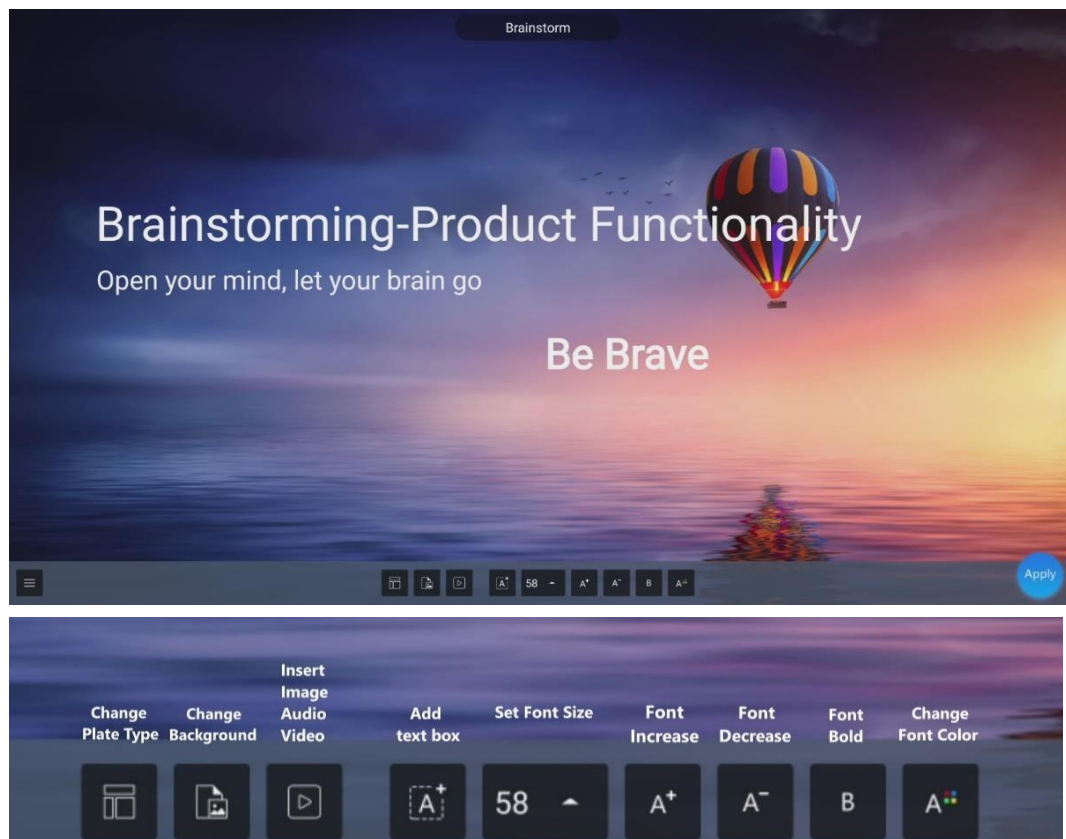

After editing the template, the user can tap the “**Apply**” icon in the lower right corner to save into “**Save Files**”, or tap the “” icon in the lower left corner to perform the following operations:

- Tap “**Restore**”: Restore the template to the default mode prior to editing.
- Tap “**Rename**”: Modify the template name.
- Tap “**Back**”: Return to the previous operation.

- Tap “**Save**” : Save the template in “**Save File**”.

Memory Usage

Tap the “” icon on the Application program to enter the **Memory Usage**. Tap “**Clear**” to clear the internal system cache.

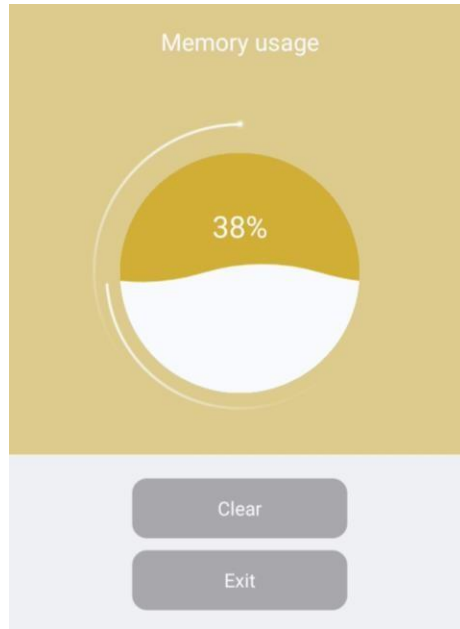

Visualizer

Tap the “” icon on the Application program to enter the Visualizer.

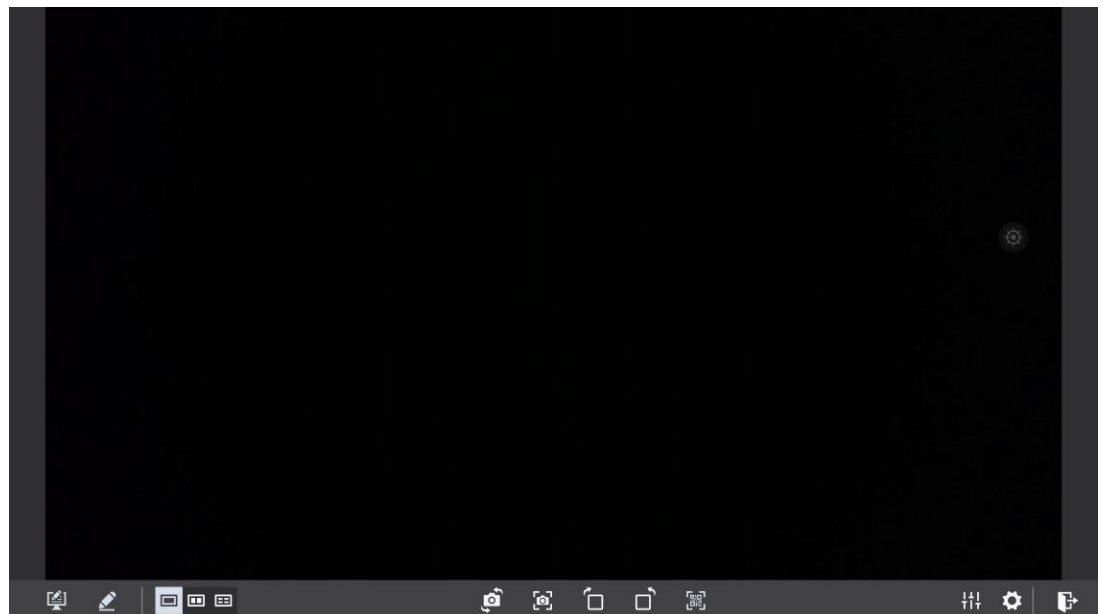



1 2 3 4 5 6 7 8 9 10 11 12 13

SN	Icon Name	Icon Function
----	-----------	---------------

1	Annotation	Tap to enter annotation mode.
2	Whiteboard	Tap to enter whiteboard mode.
3	Screen Display	Tap to display the visualizer camera.
4	Screen Split Mode (2)	Tap to display in 2 split screen mode.
5	Screen Split Mode (4)	Tap to display in 4 split screen mode.
6	Camera Switch	Tap to change the camera (only when the panel has an upper and lower camera).
7	Capture	Tap to take a screenshot, you can paste the screenshot on whiteboard, save it to files, save it to USB or Share it.
8	Rotation (clockwise direction)	Rotate the camera image by clockwise direction.
9	Rotation (counter-clockwise direction)	Rotate the camera image by counter-clockwise direction.
10	QR code	Tap to view the QR code.
11	Adjustment	Tap to adjust the brightness, contrast, saturation, sharpness.
12	Setting	Tap to set image mode, resolution, color system.
13	Exit	Tap to exit the visualizer.

4.4.5 Settings

Enter the system setting page using one of the following methods:

- Tap  on the **Home** page.
- Press  on the remote control.
- In the **Quick Setting Menu**, tap the  icon.

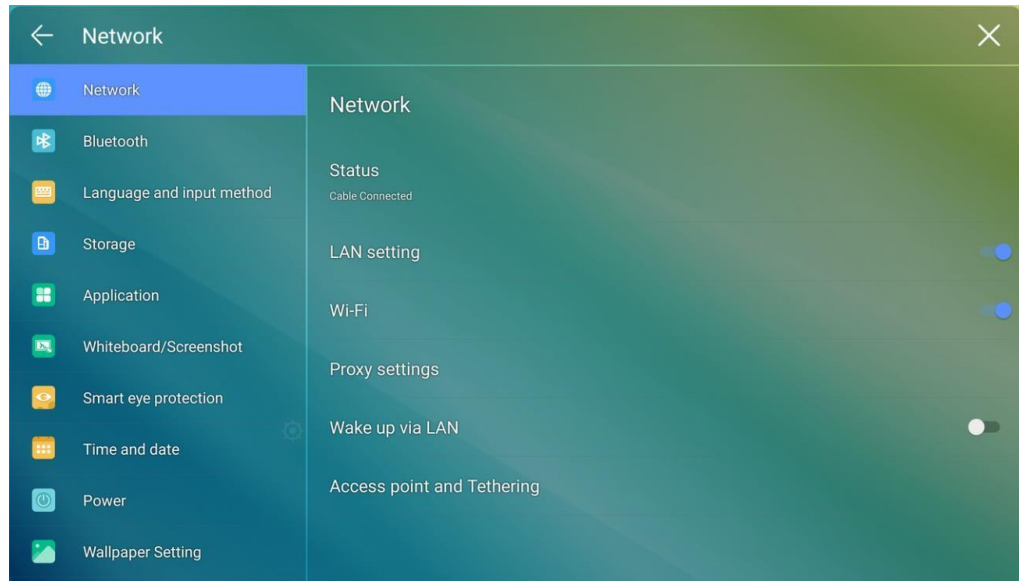

4.4.5.1 Network

Enter the **Network** submenu to set a LAN, enable Wi-Fi, view network information, and enable the Wake up via LAN function.

- **Status:** View IP address, MAC address and work time of the screen.
- **LAN setting:** Automatically obtain the LAN IP address or set static IP address according to requirements.
- **Wi-Fi:** Tap the corresponding button to enable the Wi-Fi function.
- **Proxy Settings:** The settings of the proxy server.
- **Wake up via LAN:** Tap the corresponding button to enable the Wake up via LAN function. Connect the screen and PC to the same LAN using cables, run the Wake up via LAN, and search for the IP address and MAC address that match the screen.
- **Access point and Tethering:** Tap the corresponding button to enable portable Wi-Fi hotspot, Ethernet tethering and set up Wi-Fi hotspot.

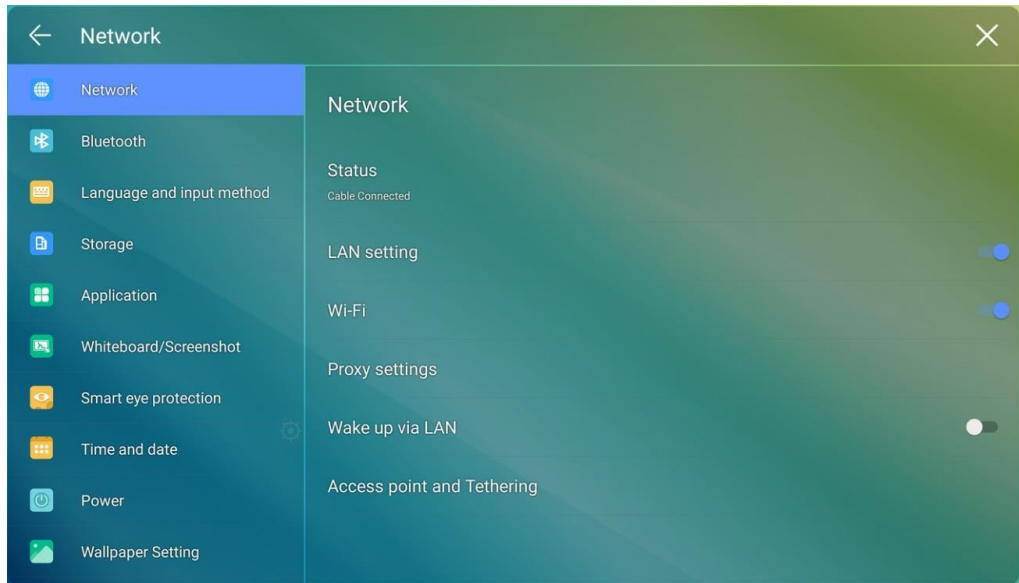

Notes:

1 Wired network and Ethernet tethering cannot be used at the same time. When using wired network, Ethernet tethering must be closed.

2 Ethernet tethering is closed by default, you can share network to OPS after you open it, and wired network will be disconnected automatically. If there is saved WiFi, the panel will connect to WiFi automatically.

4.4.5.2 Bluetooth

Enter the **Bluetooth** submenu to enable or disable the Bluetooth, send or receive files by Bluetooth.

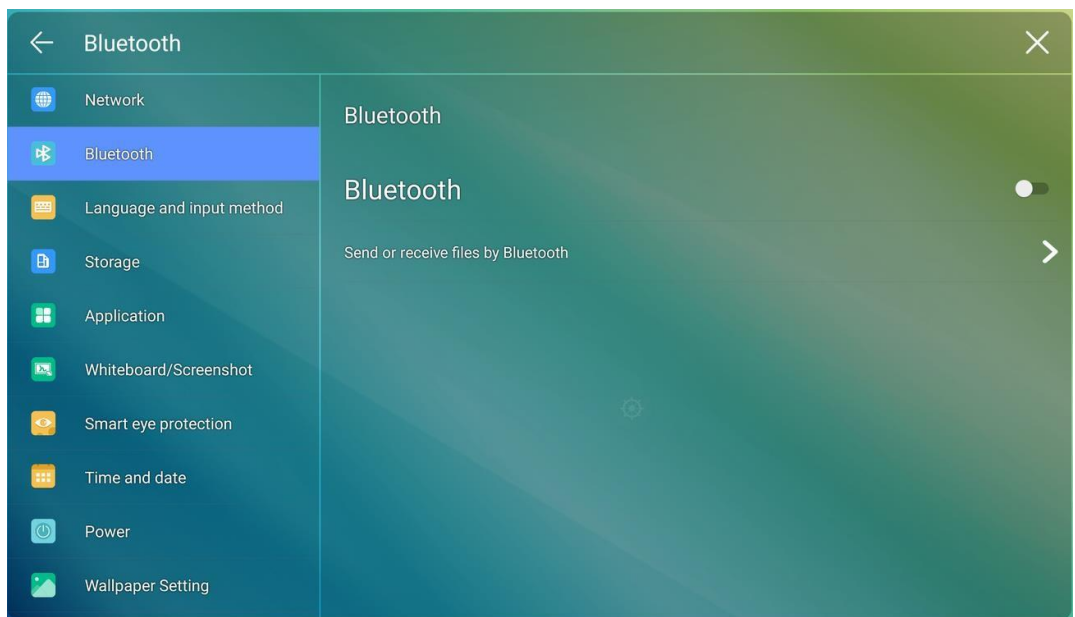

4.4.5.3 Language and Input Method

Enter the **Language & Input Method** submenu to set language and input method.

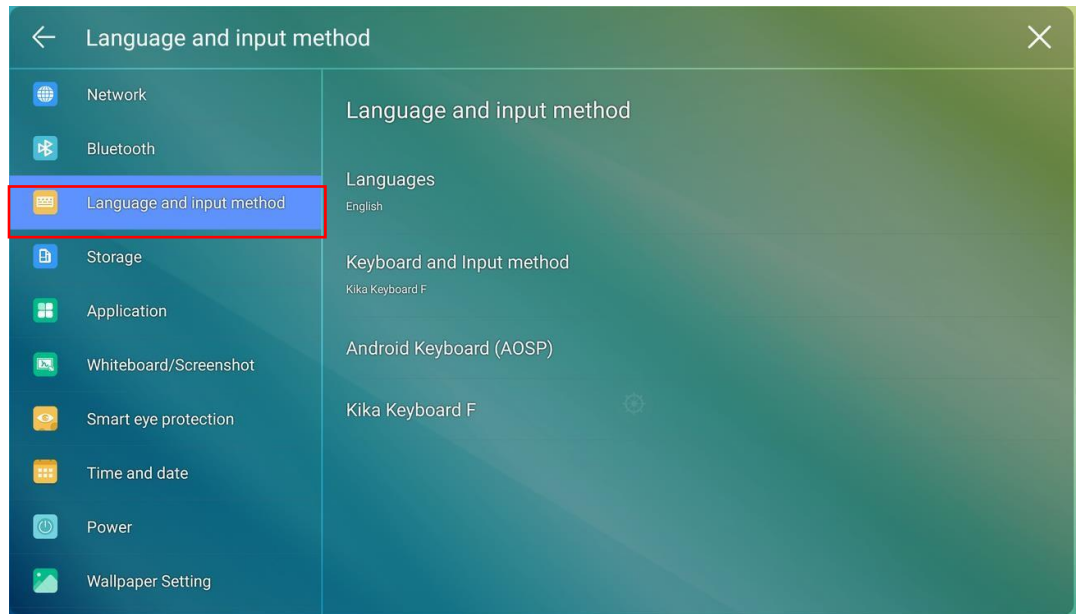

The default input method of the system is Kika Keyboard F, tap **keyboard & Input Method** to show as the following figure.

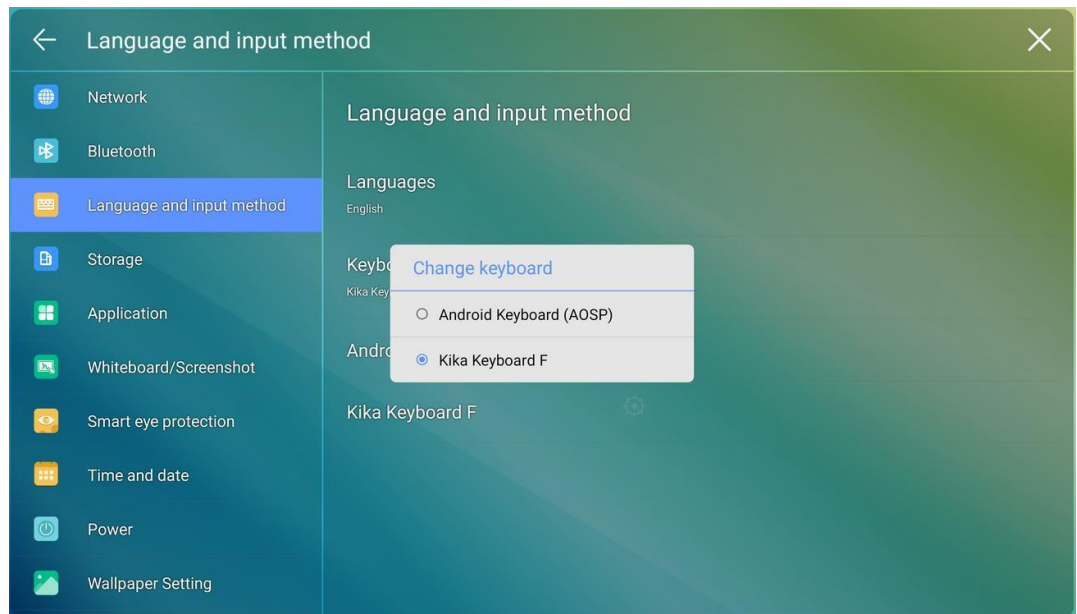

Setting a Language

Tap **Languages** at the right side. In the **Change language** dialog box that is displayed, select a language.

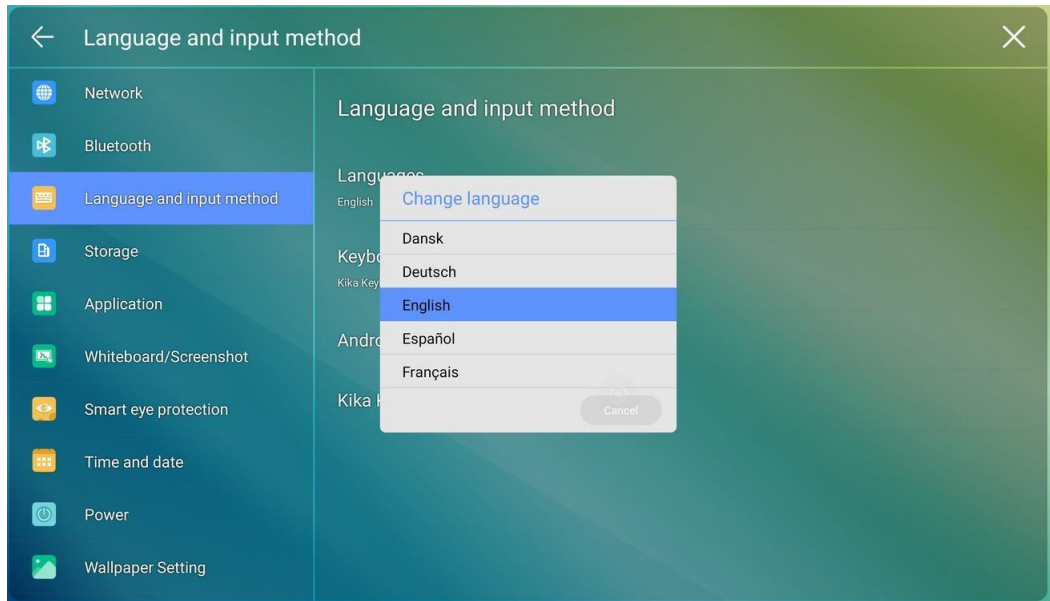

4.4.5.4 Storage

Enter the **Storage** submenu to view space distribution of the internal storage.

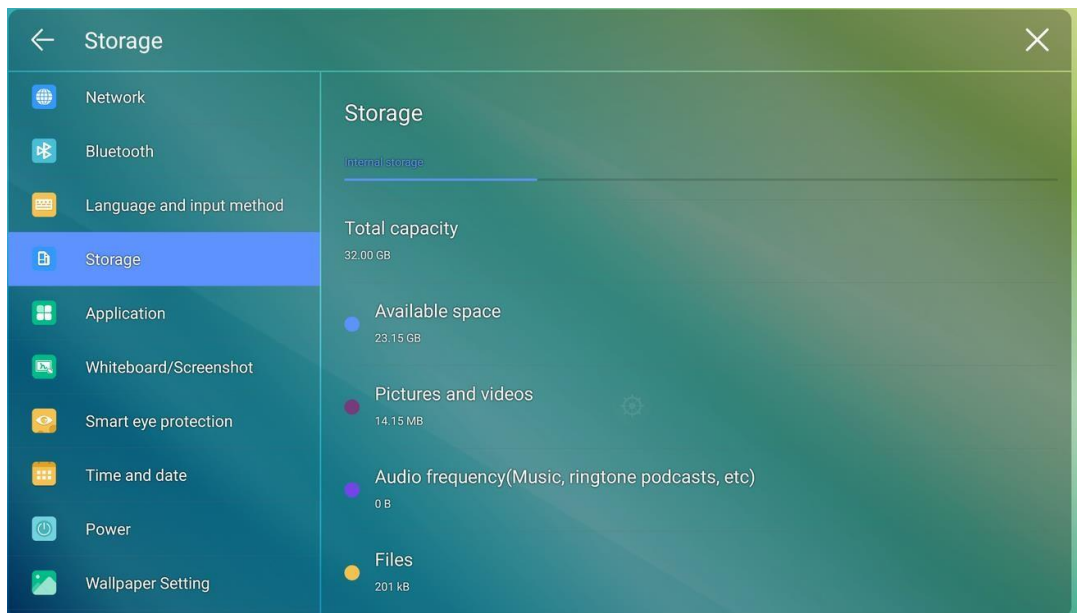

4.4.5.5 Applications

Enter the **Apps** submenu to view downloaded applications by type, running applications, and the whole applications.

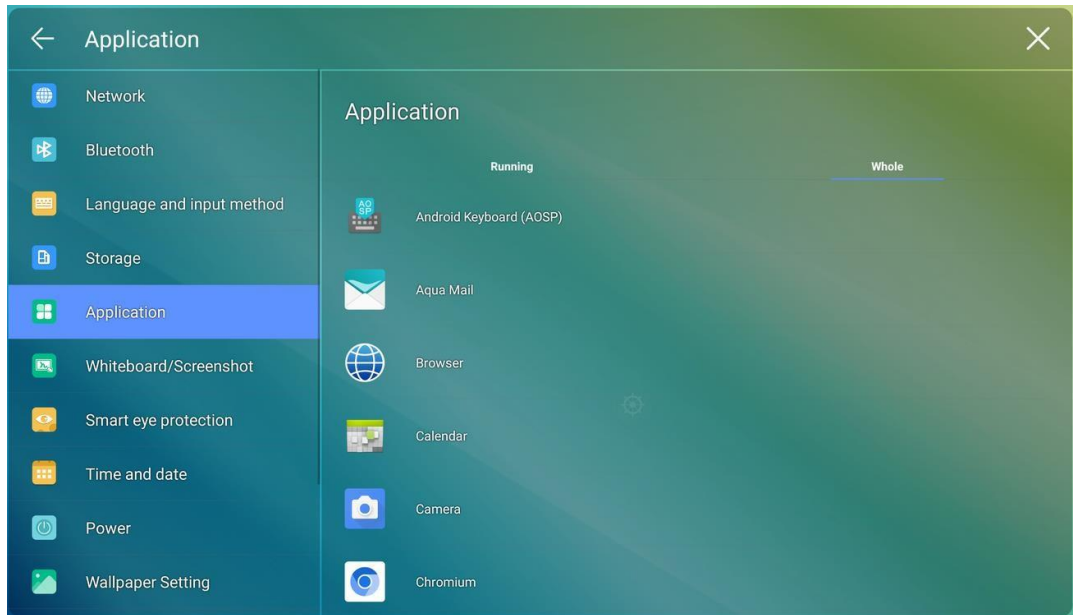

Notes:

Apps download by yourself will appear in download apps files, you can uninstall it in all apps files.

4.4.5.6 Whiteboard/Screenshot

Enter the **Whiteboard/Screenshot** submenu to set automatically clearing the whiteboard data cycle.

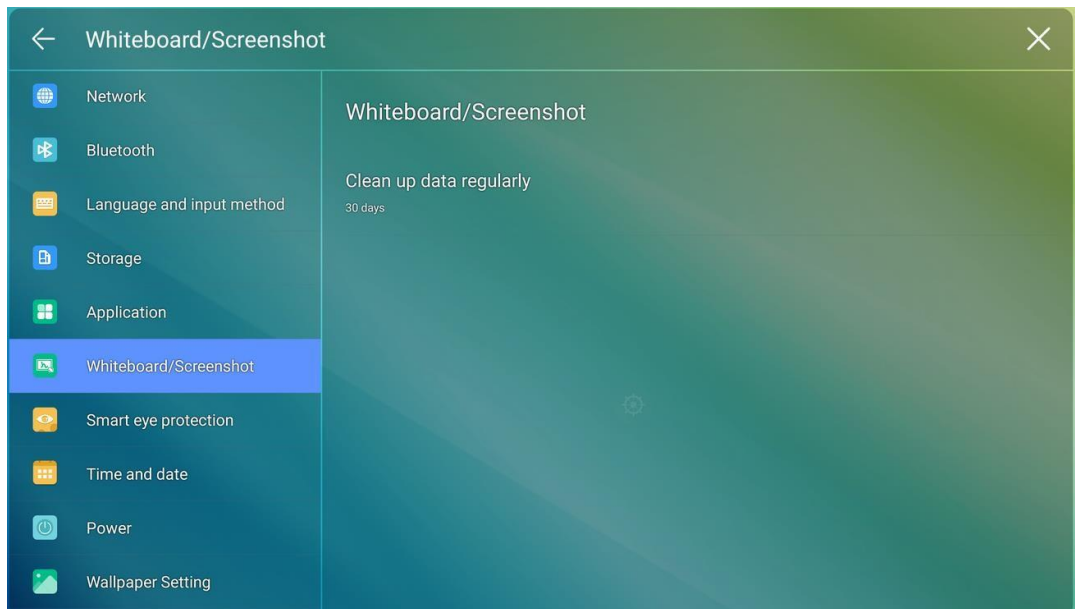

4.4.5.7 Smart Eye Protection

Enter the **Smart Eye Protection** submenu to set **Eye care writing**, **Eye protection and light control** and **Blue light filter**.

- **Eye care writing:** Tap to turn on/off the function. The panel will change the brightness of whiteboard in writing state when the function is on.
- **Eye protection and light control:** Tap to turn on/off the function. The panel will Changing screen brightness according to ambient light when the function is on.
- **Blue light filter:** Tap to turn on/off the function. You can drag the slider to adjust the Filter level only when Blue light filter is on.

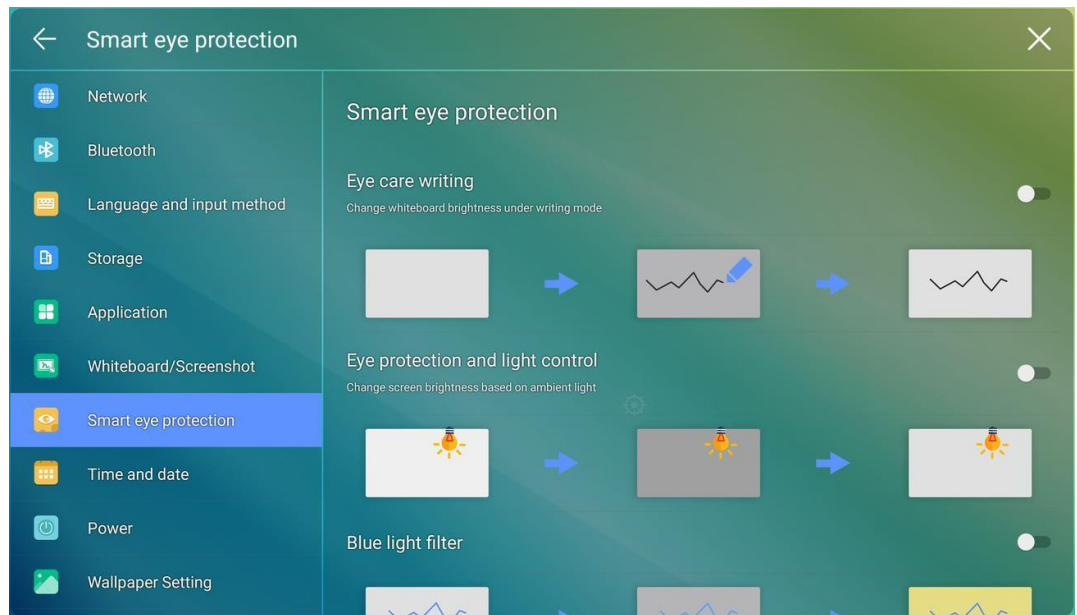

4.4.5.8 Time and Date

Enter the **Time and Date** submenu to set the date and time. Before setting the date and time, users should tap **Select time zone** to select local time zone.

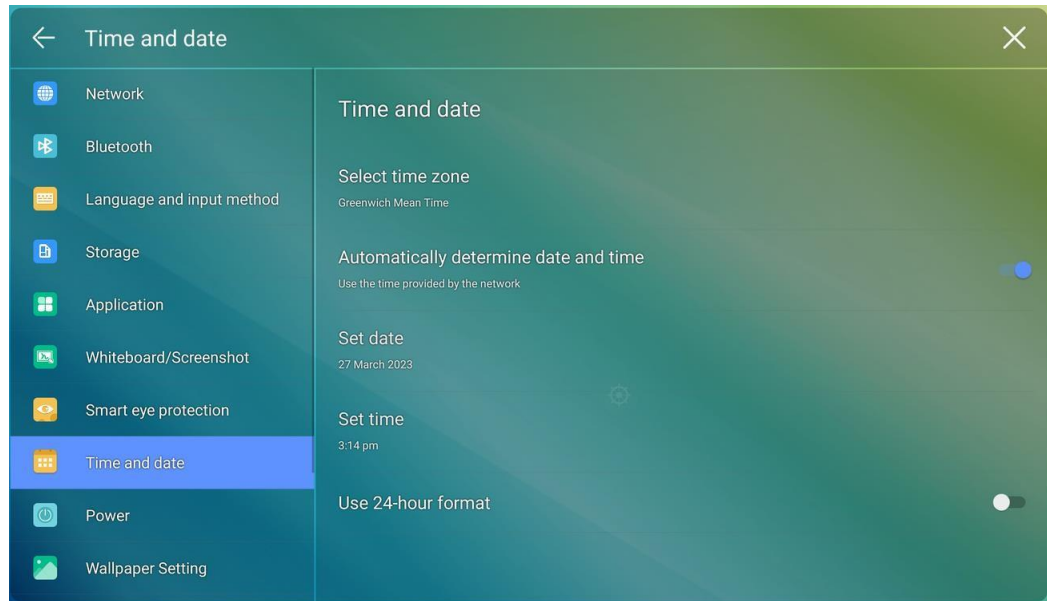

Setting a Date

You can automatically obtain the system date or customize a date.

- To automatically obtain a date, select **Automatic date & time**.

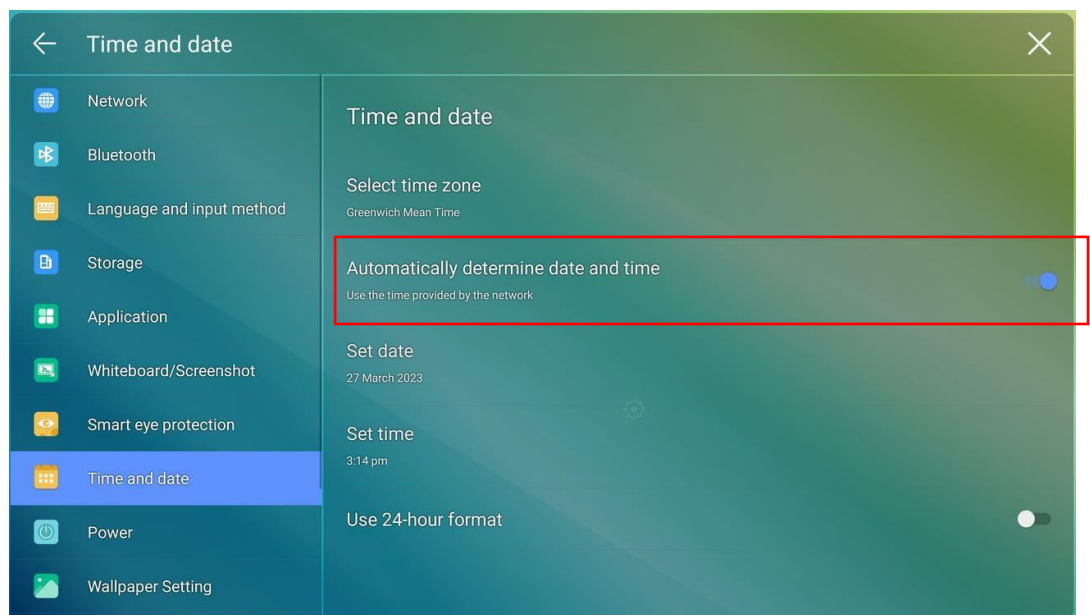

- To customize a date and date format, set them in **Set date**.

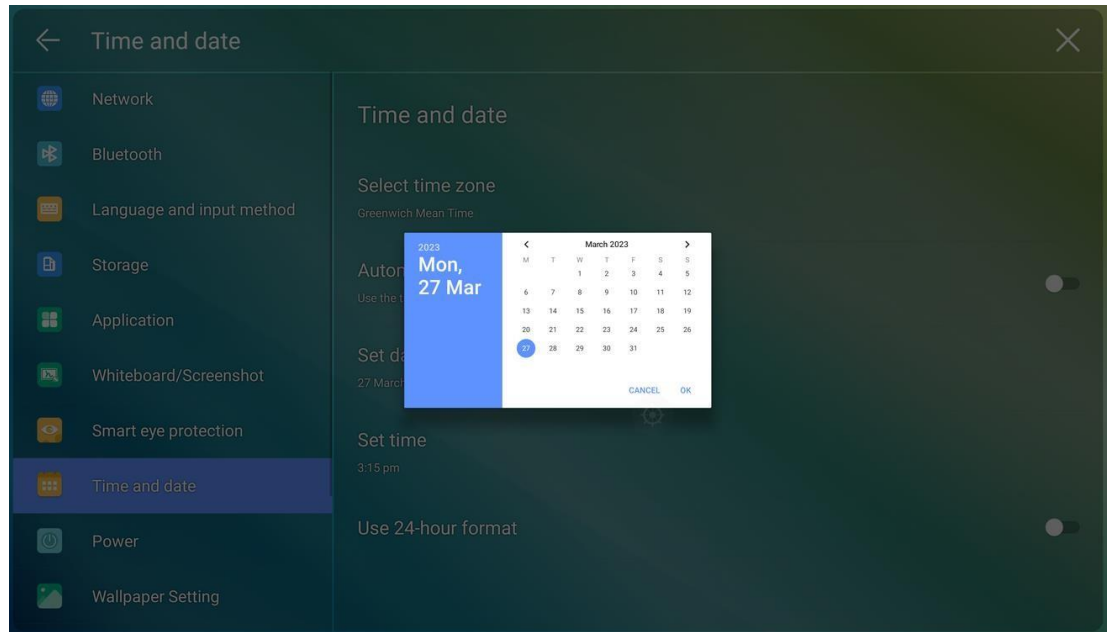

Setting Time

You can automatically obtain the system time or customize time.

- To automatically obtain time, select **Automatic date & time**.

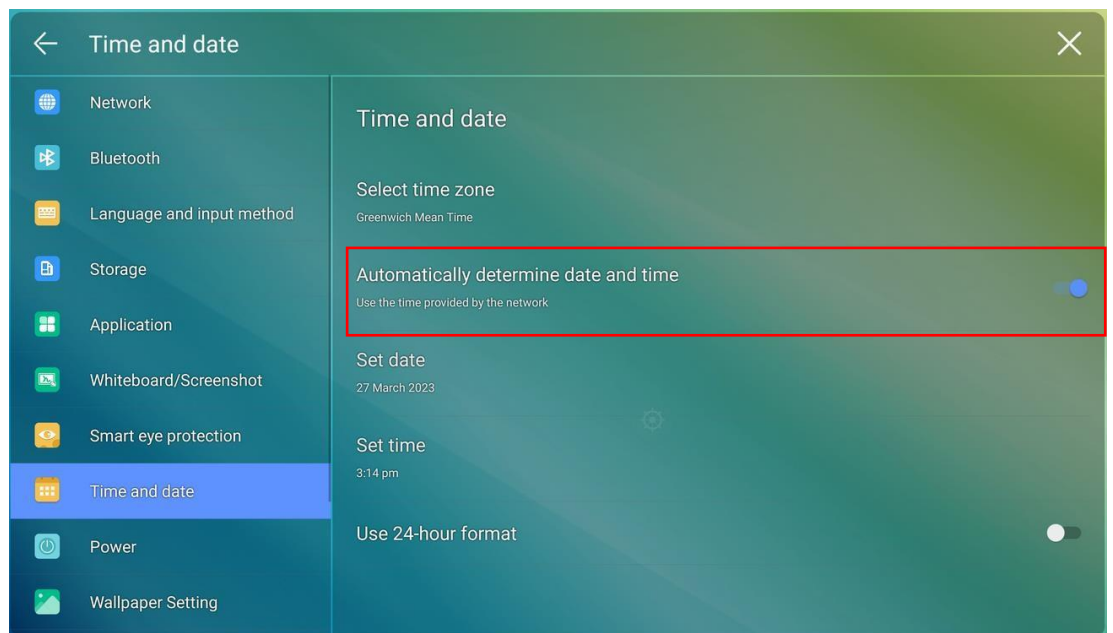

- To customize time and time format, set them in **Set time** and **Use 24-hour format**.

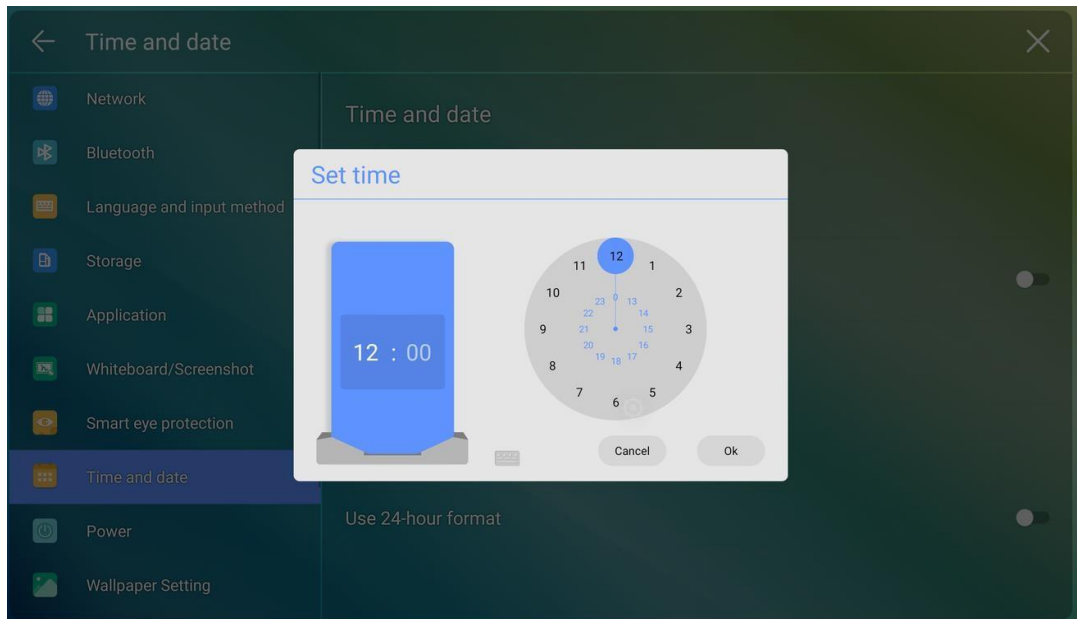

 **NOTE**

*Time format will be 24-hours mode only when the **Use 24-hour format** is selected, otherwise time format will be 12 hours mode.*

4.4.5.9 Power

Enter the **Power** submenu to set automatic power on/off time, the time for the system to enter the power off mode and the automatic power on/off function of the consumer electronics control (CEC) device.

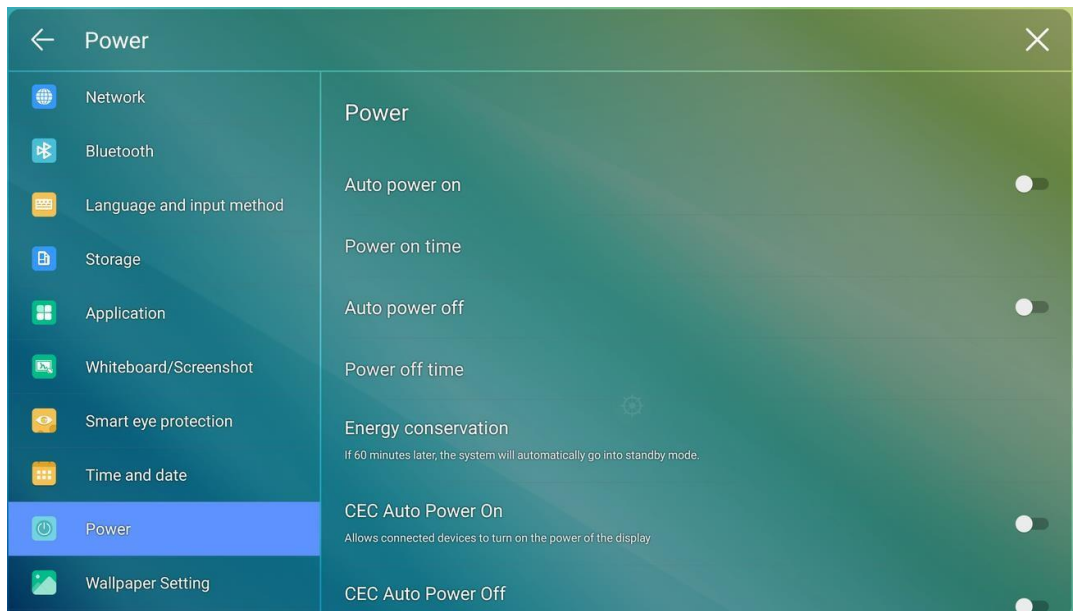

- To set the automatic power on time, select **Auto power on**, and set the power on time in **Power on time**, as shown in the following figure.

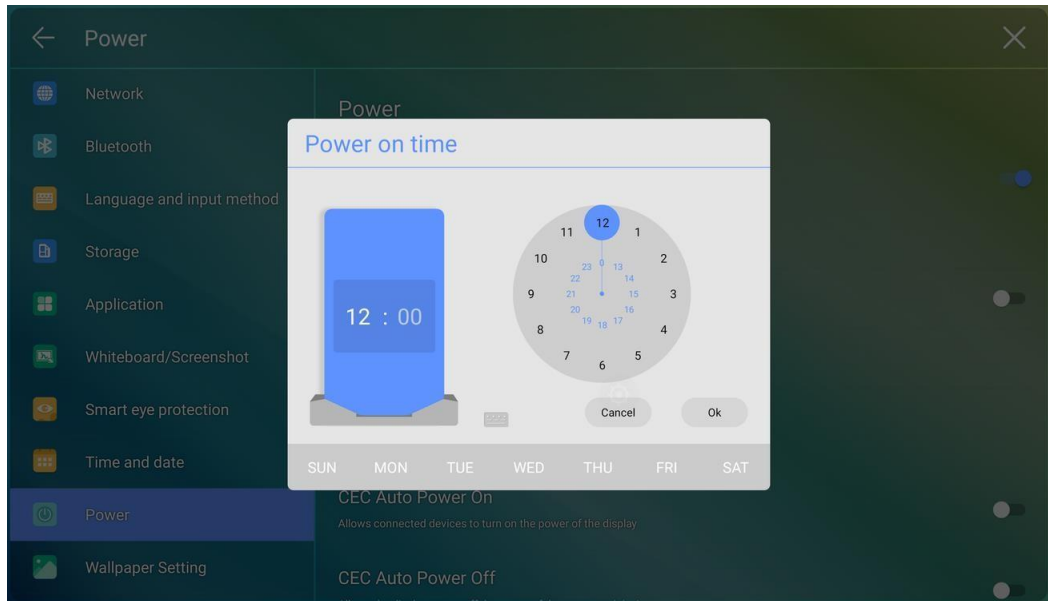

- To set the automatic power off time, select **Auto power off**, and set the power off time in **Power off time**, as shown in the following figure.

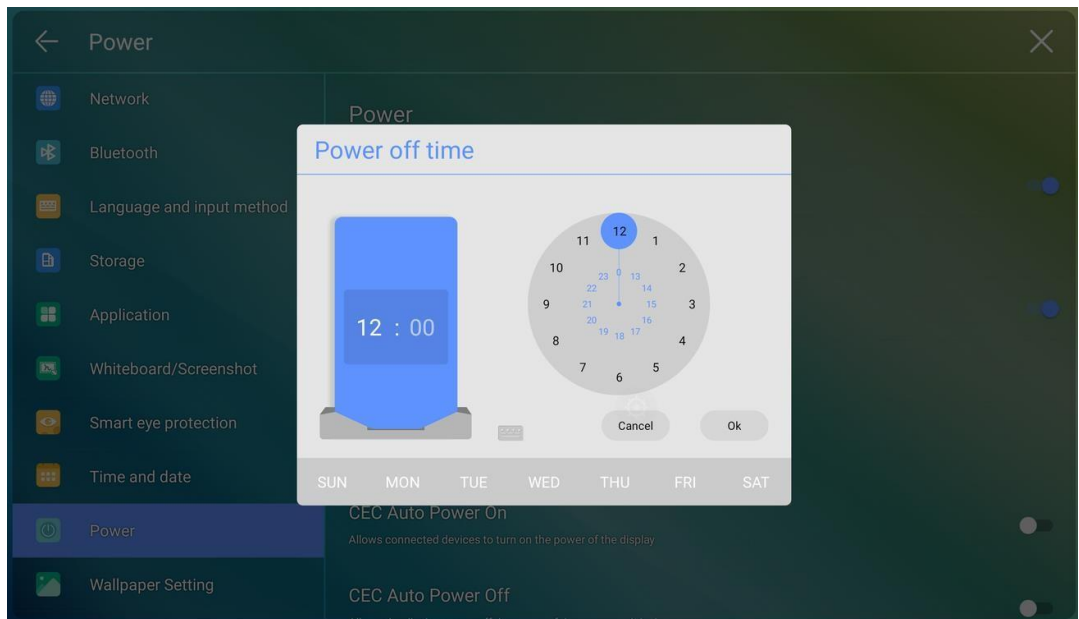

- To set the energy saving time, tap **Energy saving**. In the dialog box that is displayed, set a duration after which the screen enters the lock mode if the screen is left un-operated. After the screen is locked, if the user does not operate the screen within 120s, the screen enters the power off mode. The duration can be set to **30 MIN**, **60 MIN**, **90 MIN**, or **NEVER**. You can also customize this duration and the range is 3 minutes to 480 minutes.



NOTE

NEVER indicates that the automatic power off mode function is not enabled.

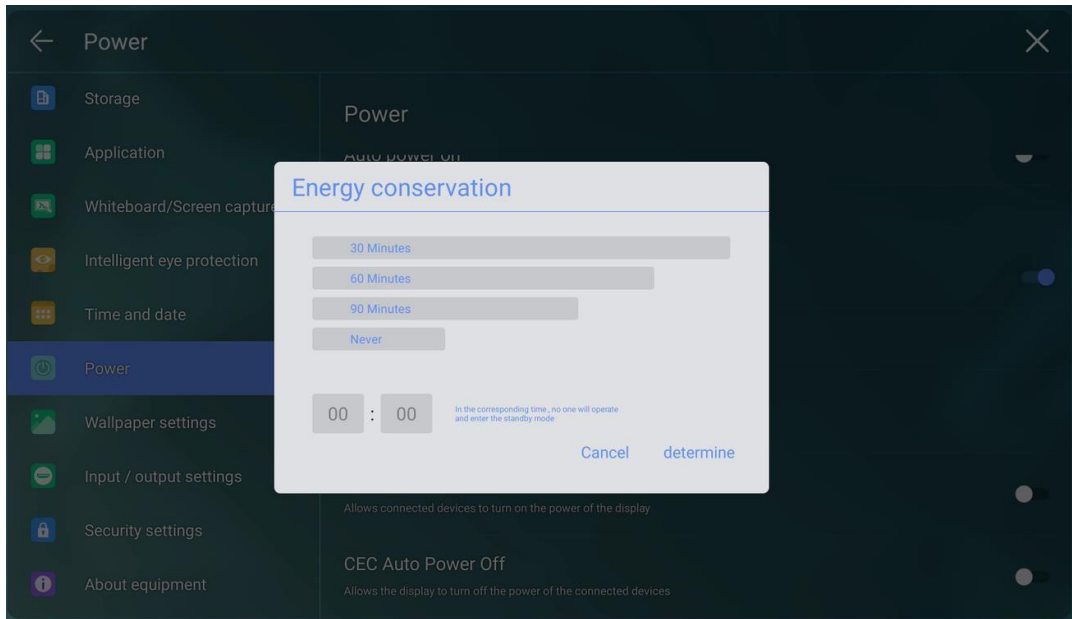

- After the **CEC auto power on** function is enabled and the screen is connected with the CEC device via the HDMI port, the screen automatically starts if the CEC device starts and the screen receives a CEC power on command.
- After the **CEC auto power off** function is enabled and the screen is connected with the CEC device via the HDMI port, the CEC device automatically stops if the screen stops and the CEC device receives a CEC power off command.

4.4.5.10 Wallpaper Setting

Enter the **Wallpaper Setting** submenu to set background.

In the page, tap + to select the picture locally as the wallpaper. Tap  to delete the selected picture.

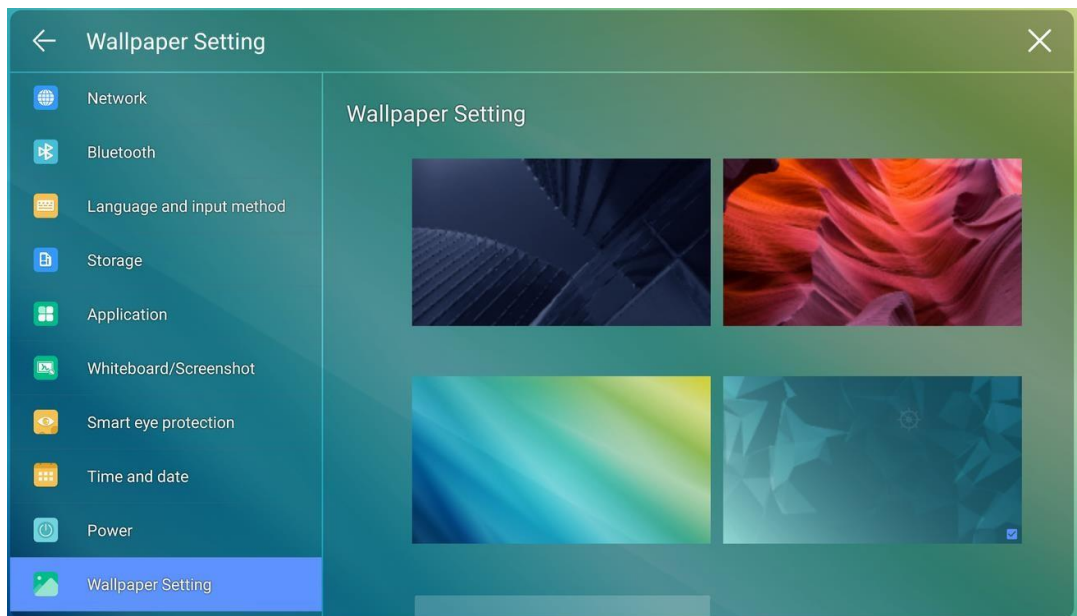

4.4.5.11 Input / Output Setting

Enter the **Input / Output Setting** submenu to set the favorite source, starting source, new signal source, and resolution of image output through the HDMI port.

- **Favorite source:** Set the commonly used signal source. After that, the shortcut key for the signal source will be displayed in the main toolbar.
- **C key function:** Set the commonly used function for C button on the front panel. Default is Freeze, options included: Visualizer/Screenshot/Sound only/ Touch Lock /Built-in PC/HDMI Front/HDMI Rear 1/HDMI Rear 2/Display port/VGA/Type-C/Annotation/Task preview/Freeze.
- **Power signal:** Set the signal source entered after power on (Android> Last known Source> Favorite source).
- **HDMI OUT:** Set the output format of HDMI OUT port.
- **New access signal source:** After the function is enabled, the system can automatically switch to the screen of the newly connected signal source.
- **New access signal open:** After the function is enabled, connecting a new signal source in standby mode, the panel will wake up and enter the newly signal source channel.

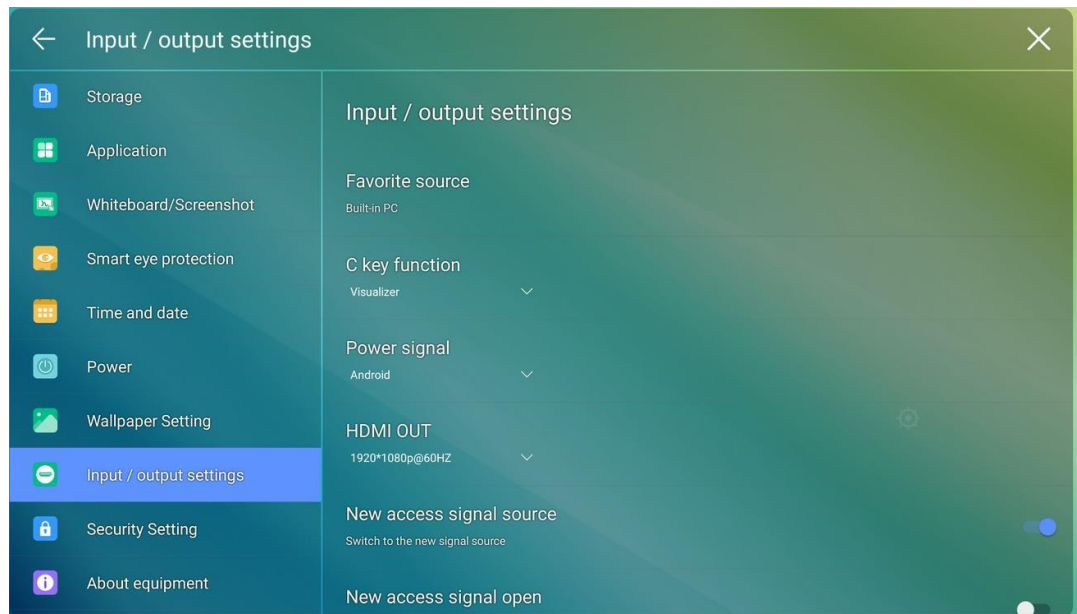

4.4.5.12 Security Setting

Enter the **Security Setting** submenu to set Passkey lock, Setting lock and view credential storage.

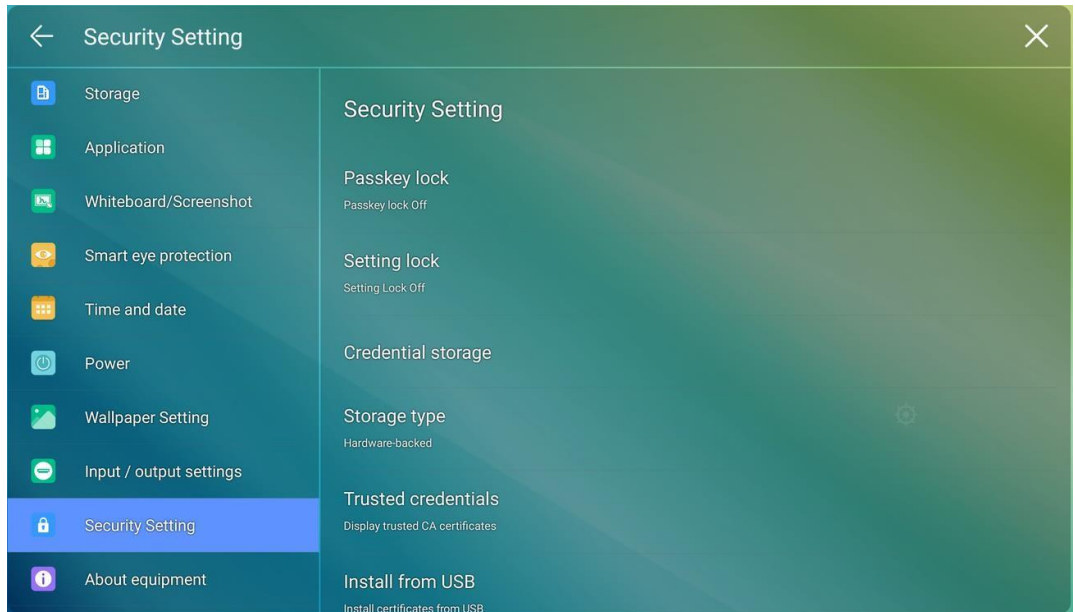

- **Passkey lock:** Set whether you need enter the password and modified password from the Start page to the Home page. The password is only limited to digits whose number is at least 4, English letters are not allowed.

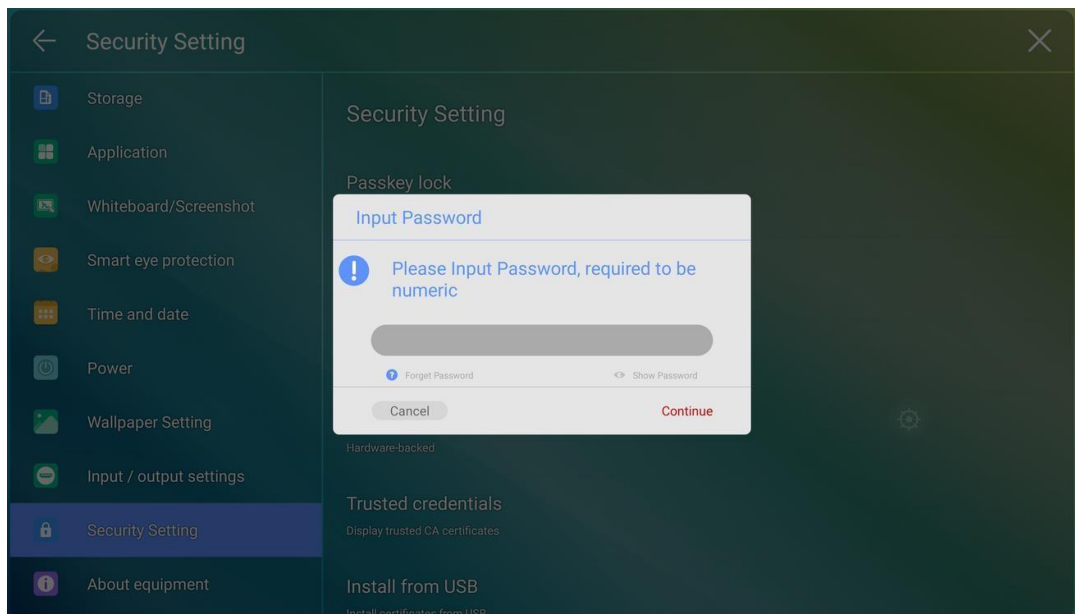

*Note: When you forgot the password, tap **Forgot passkey** under the **Enter passkey** page to enter the **Reset passkey** page, enter the $\uparrow\uparrow\downarrow\downarrow\leftarrow\leftarrow\rightarrow\rightarrow$ command with the remote control and tap **OK** again, the original password will be invalid after entering it.*

- **Settings lock:** When you enable the setting lock, the setting-related icons will be displayed as locked, if you would like to do the setting, need to enter the admin mode and turn it off.
- **Encryption & credentials:** Tap the icon to view the Encrypt device and user credentials, install a certificate and clear credentials.

4.4.5.13 About

Enter the **About** submenu to update system or reset to the factory data, you also can view firmware, system version information and serial number.

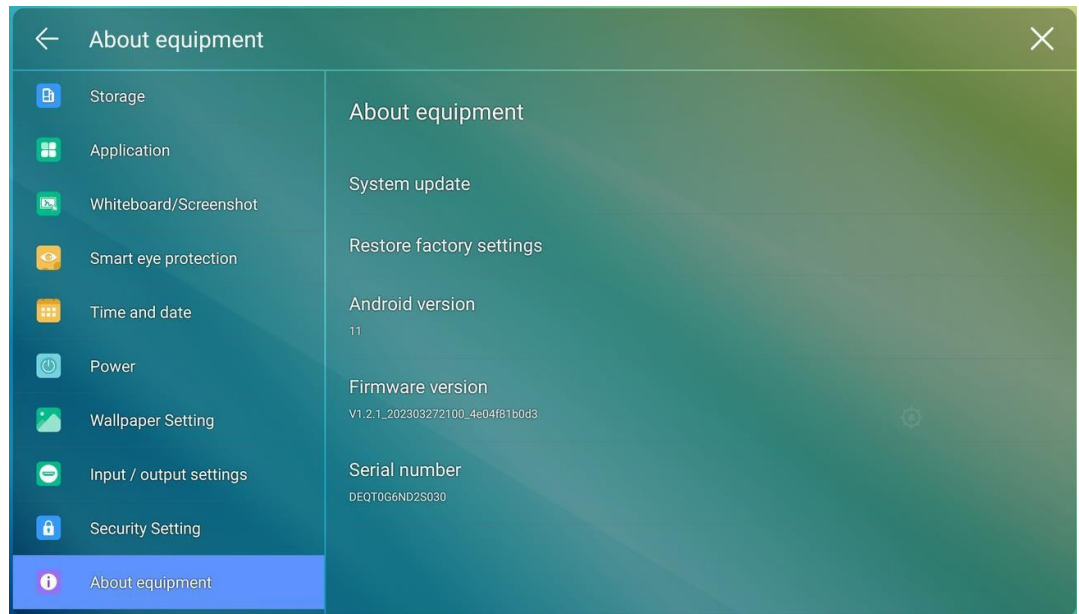







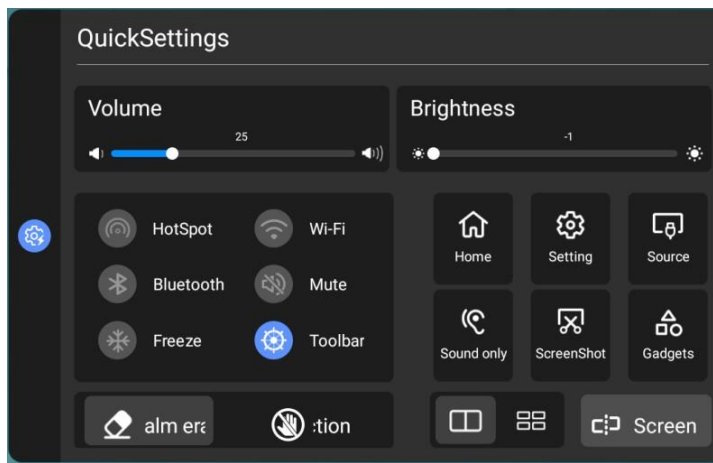











5 Quick Setting Menu

5.1 Quick Setting Menu

Using two fingers and swipe up from the bottom of the screen to access the Quick Settings menu, as shown in the following figure.



Icon	Functions
	Drag the slider to adjust the volume.
	Drag the slider to adjust the brightness.
	Tap the icon to enable or disable the hotspot.
	Tap the icon to enable or disable the embedded operating system Wi-Fi.
	Tap the icon to enable or disable the Bluetooth.
	Tap the icon to enable the Freeze Function.
	Tap the icon to mute/unmute.

Icon	Functions
	Tap the icon to appear or disappear the toolbar.
	Tap the icon to enable or disable Palm eraser.
	Tap the icon to enable or disable Palm Rejection.
	Tap the icon to return to Home page.
	Tap the icon to enter the settings page.
	Tap the icon to access the signal source.
	Tap the icon to enable sound only mode. In sound only mode, the screen LCD displays and LED backlight turns off, other functions will continue to work as normal.
	Tap the icon to access the screenshot.
	Tap the icon to choose timer, stopwatch, spotlight and calculator application.
	Tap the icon to choose the app to enter split screen.
	Tap the icon to enter four split screen mode.
	Tap the icon and choose an app to use in split screen.

5.2 Automatically Power Off

If the screen is left un-operated for a specified duration, it will be locked to guarantee your privacy. Choose Settings> Power Setting to set the duration. For details on the setting method, see "**Error! Reference source not found.**".

After the screen is locked, if it is operated again within 120 seconds, the screen is unlocked. Otherwise, the screen enters the power off mode.

6 Serial Port Control

RS232 communication cable (please use cross data cables)

PIN	This Device	Computer
1	NC	NC
2	RXD0	TXD0
3	TXD0	RXD0
4	NC	NC
5	GND	GND
6	NC	NC
7	NC	NC
8	NC	NC
9	NC	NC
Cover	GND	GND

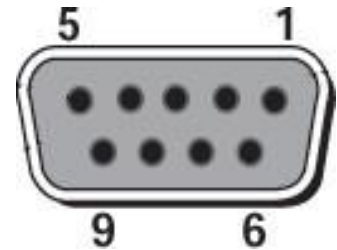

RS232 port of panel

Connect RS-232 port to the PC or controlling product. Enable RS-232 serial port connection and complete the following configuration.

Port: COM1 (Set according to PC or controlling product's port number)			
Baud rate	19200	Odd/even check	None
Data bits	8	Stop bit	1

The following tables list controlling codes, querying codes and return codes.

Function	Controlling codes	Return codes
Power on	7F 08 99 A2 B3 C4 02 FF 01 00 CF	7F 09 99 A2 B3 C4 02 FF 01 00 01 CF
Power off	7F 08 99 A2 B3 C4 02 FF 01 01 CF	7F 09 99 A2 B3 C4 02 FF 01 01 01 CF
Mute/Unmute	7F 08 99 A2 B3 C4 02 FF 01 02 CF	7F 09 99 A2 B3 C4 02 FF 01 02 01 CF
Signal source	7F 08 99 A2 B3 C4 02 FF 01 06 CF	7F 09 99 A2 B3 C4 02 FF 01 06 01 CF
Enable whiteboard	7F 08 99 A2 B3 C4 02 FF 01 07 CF	7F 09 99 A2 B3 C4 02 FF 01 07 01 CF
Display status	7F 08 99 A2 B3 C4 02 FF 01 09 CF	7F 09 99 A2 B3 C4 02 FF 01 09 01 CF
HDMI front	7F 08 99 A2 B3 C4 02 FF 01 0A CF	7F 09 99 A2 B3 C4 02 FF 01 0A 01 CF
HDMI rear 1	7F 08 99 A2 B3 C4 02 FF 01 52 CF	7F 09 99 A2 B3 C4 02 FF 01 52 01 CF
HDMI rear 2	7F 08 99 A2 B3 C4 02 FF 01 53 CF	7F 09 99 A2 B3 C4 02 FF 01 53 01 CF
VGA	7F 08 99 A2 B3 C4 02 FF 01 54 CF	7F 09 99 A2 B3 C4 02 FF 01 54 01 CF
Internal PC	7F 08 99 A2 B3 C4 02 FF 01 38 CF	7F 09 99 A2 B3 C4 02 FF 01 38 01 CF
DP	7F 08 99 A2 B3 C4 02 FF 01 56 CF	7F 09 99 A2 B3 C4 02 FF 01 56 01 CF
Page up	7F 08 99 A2 B3 C4 02 FF 01 13 CF	7F 09 99 A2 B3 C4 02 FF 01 13 01 CF
Page down	7F 08 99 A2 B3 C4 02 FF 01 14 CF	7F 09 99 A2 B3 C4 02 FF 01 14 01 CF
VOL -	7F 08 99 A2 B3 C4 02 FF 01 17 CF	7F 09 99 A2 B3 C4 02 FF 01 17 01 CF
VOL +	7F 08 99 A2 B3 C4 02 FF 01 18 CF	7F 09 99 A2 B3 C4 02 FF 01 18 01 CF
Menu	7F 08 99 A2 B3 C4 02 FF 01 1B CF	7F 09 99 A2 B3 C4 02 FF 01 1B 01 CF
Home page	7F 08 99 A2 B3 C4 02 FF 01 1C CF	7F 09 99 A2 B3 C4 02 FF 01 1C 01 CF
Return (exit)	7F 08 99 A2 B3 C4 02 FF 01 1D CF	7F 09 99 A2 B3 C4 02 FF 01 1D 01 CF

OK	7F 08 99 A2 B3 C4 02 FF 01 2B CF	7F 09 99 A2 B3 C4 02 FF 01 2B 01 CF
←	7F 08 99 A2 B3 C4 02 FF 01 2C CF	7F 09 99 A2 B3 C4 02 FF 01 2C 01 CF
→	7F 08 99 A2 B3 C4 02 FF 01 2D CF	7F 09 99 A2 B3 C4 02 FF 01 2D 01 CF
↑	7F 08 99 A2 B3 C4 02 FF 01 2E CF	7F 09 99 A2 B3 C4 02 FF 01 2E 01 CF
↓	7F 08 99 A2 B3 C4 02 FF 01 2F CF	7F 09 99 A2 B3 C4 02 FF 01 2F 01 CF
Set volume	7F 08 99 A2 B3 C4 02 FF 05 XX CF	7F 09 99 A2 B3 C4 02 FF 05 XX 01 CF Note: XX indicates the value of volume (0-100), corresponding to the hexadecimal number system (00 - 64).
Query the firmware version number	7F 08 99 A2 B3 C4 02 FF 01 3D CF	7F 09 99 A2 B3 C4 02 FF 01 3D XX CF Note: XX indicates version.
Set display mode	7F 08 99 A2 B3 C4 02 FF 06 XX CF	7F 09 99 A2 B3 C4 02 FF 06 XX 01 CF Note: XX indicates the mode. 00-standard, 01-ECO mode, 02-custom, 03-auto.
Enable the annotation function	7F 08 99 A2 B3 C4 02 FF 01 40 CF	7F 09 99 A2 B3 C4 02 FF 01 40 01 CF
Increase backlight brightness	7F 08 99 A2 B3 C4 02 FF 01 47 CF	7F 09 99 A2 B3 C4 02 FF 01 47 01 CF
Decrease backlight brightness	7F 08 99 A2 B3 C4 02 FF 01 48 CF	7F 09 99 A2 B3 C4 02 FF 01 48 01 CF
Set the value of backlight brightness	7F 08 99 A2 B3 C4 02 FF 09 XX CF	7F 09 99 A2 B3 C4 02 FF 09 XX 01 CF Note: XX indicates the value of backlight brightness (1- 100), corresponding to the hexadecimal number system (01-64).

Switch backlight	7F 08 99 A2 B3 C4 02 FF 01 15 CF	7F 09 99 A2 B3 C4 02 FF 01 15 XX CF Note: <ul style="list-style-type: none"> • XX = 01 indicates the backlight is on. • XX = 00 indicates the backlight is off.
Switch to screen lock	7F 08 99 A2 B3 C4 02 FF 01 57 CF	7F 09 99 A2 B3 C4 02 FF 01 57 01 CF
Screenshot	7F 08 99 A2 B3 C4 02 FF 01 1F CF	7F 09 99 A2 B3 C4 02 FF 01 1F 01 CF
Settings	7F 08 99 A2 B3 C4 02 FF 01 20 CF	7F 09 99 A2 B3 C4 02 FF 01 20 01 CF

Function	Querying codes	Return codes
Power supply	7F 08 99 A2 B3 C4 02 FF 01 37 CF	7F 09 99 A2 B3 C4 02 FF 01 37 XX CF Notes: XX indicates the power on/off state. XX = 01: power on state; XX = 00: power off state.
Speaker	7F 08 99 A2 B3 C4 02 FF 01 82 CF	7F 09 99 A2 B3 C4 02 FF 01 82 XX CF Notes: 01: mute; 00: non-mute.
Current signal source	7F 08 99 A2 B3 C4 02 FF 01 50 CF	7F 09 99 A2 B3 C4 02 FF 01 50 XX CF Notes: Smart system = 30; PC = 17; DP = 20; HDMI rear 1 = 1F; HDMI Rear 2 = 1E; VGA = 00; HDMI Front = 19; Type C = 18.
Speaker volume	7F 08 99 A2 B3 C4 02 FF 01 33 CF	7F 09 99 A2 B3 C4 02 FF 01 33 XX CF Notes: XX indicates current volume value (XX is a hexadecimal value, range: 00~64). For example, XX = 20 indicates current volume value is 32 (decimal value), XX = 00 indicates mute state.

D.Mode	7F 08 99 A2 B3 C4 02 FF 01 35 CF	7F 09 99 A2 B3 C4 02 FF 01 35 XX CF Notes: XX indicates the mode. XX = 00-standard; XX = 01-ECO mode; XX = 02-custom. XX = 03-auto.
Backlight brightness	7F 08 99 A2 B3 C4 02 FF 01 49 CF	7F 09 99 A2 B3 C4 02 FF 01 49 XX CF Notes: XX indicates the value of backlight brightness (0 - 100), corresponding to the hexadecimal number system (00 - 64).
Backlight status	7F 08 99 A2 B3 C4 02 FF 01 81 CF	7F 09 99 A2 B3 C4 02 FF 01 81 XX CF Notes: XX = 00 indicates the backlight is on. XX = 01 indicates the backlight is off.
Screen lock status	7F 08 99 A2 B3 C4 02 FF 01 84 CF	7F 09 99 A2 B3 C4 02 FF 01 84 XX CF Notes: XX = 01 indicates the child safety lock is on. XX = 00 indicates the child safety lock is off.
Whiteboard state	7F 08 99 A2 B3 C4 02 FF 01 83 CF	7F 09 99 A2 B3 C4 02 FF 01 83 XX CF Notes: XX = 01 indicates the whiteboard state. XX = 00 indicates non-whiteboard state.
Return to system state of the previous options	7F 08 99 A2 B3 C4 02 FF 0A 00 CF	7F 08 99 A2 B3 C4 02 FF 0A 00 AB CD EF GH IJ OP QR ST UV CF Notes: AB: Power supply; CD: Speaker; EF: Current signal source; GH: Speaker volume; IJ: D.Mode;

		<p>OP: backlight brightness; QR: backlight state; ST: Whiteboard state; UV: Screen lock state.</p>
--	--	--

7

FAQs & Troubleshooting

Symptom	Troubleshooting Methods
The screen cannot be powered on or the power indicator light is off.	Check whether the power supply is connected.
	Check whether the power supply plug is properly connected.
	Check whether the power outlet has electricity.
	Check whether the rocker switch is enabled.
	Press the reset switch and start the system again.
The remote control is not causing a response.	Replace the batteries.
	Check whether the polarity direction of the batteries is correct.
	Align the remote control with the IR receiver window. For details, see section "Remote Control".
The image is normal but there is no sound.	Increase volume on both the screen and the Windows system.
	Check whether the screen and the Windows system are muted.
	If an external computer is connected, check whether the connection cables are normal.
The system is automatically powered on/off when no operation is being performed.	Disable the automatic power-on/off function. For details, see section "Power ON/OFF Setting".
	Check whether the screen entered shut down mode due to no operation for an extended period of time.
	Check whether the input power supply is stable.
The colors of images are abnormal.	Check whether the HDMI cable is properly connected or has any quality issue.
The touch function is abnormal or the positioning is inaccurate.	Restart the screen.
	In the Windows system, recalibrate the screen. For details, see section "Calibration".
The touch function is unavailable when	Switch between different external signal sources.

Symptom	Troubleshooting Methods
the external signal source channel is being used.	Ensure that the USB touch cable is connected to the proper port. For details, see section "Ports".
	Remove and insert the USB touch cable again.
There is no sound when the HDMI in channel is used.	Remove and insert the HDMI cable again.
No image is displayed when the HDMI out channel is used.	Generally, this issue is caused by the compatibility of the external display product. Replace the external display product and test again.
	The HDMI cable is too long or has a poor quality. Replace the HDMI cable delivered with the product.
The touch function on the front panel is ineffective.	Touch the button using your full fingertip.
	Check whether the finger is wet or has other liquids on it.
	Restart the screen.
The USB flash drive cannot be identified.	Check whether the USB flash drive is inserted into the correct USB port. For details, see section "Ports."
The conference records cannot be saved on the USB flash drive, and the system prompts "The target storage product has no write permissions."	Format the USB flash drive to the FAT32 format.
The OPS has no signal.	Check whether the OPS is properly inserted in the slot.
	Check whether the OPS is in shut down mode.
	Press the power button on the OPS (for details, see the instructions of the OPS), and manually start up the OPS.
In the embedded operating system or Windows system, no wireless network can be found or the wireless network signal is weak.	Check whether the Wi-Fi antenna is properly installed on the embedded operating system. For details, see section "Ports".
	Check whether the Wi-Fi antenna is properly installed for the OPS.
The keyboard is not correctly displayed.	Confirm that the hardware keyboard is enabled.
When you connect a handheld microphone to a port on the front panel, the distance from user to microphone should be no less than 1 meter, otherwise the sound may distort.	The front panel doesn't support handheld microphone, and needs to use the fixed microphone. To make sure of the sound quality, the distance from user to microphone should be no less than one meter.

Symptom	Troubleshooting Methods
When the touch screen connects to CEC facilities and powers down, touch screen will stay in shut down mode after power restart. CEC facilities can't recall the touch screen.	Please use the remote control to start and turn off the touch screen. Then you can use the CEC facilities to recall it.

8 Specifications

Model	65inch	75inch	86inch
Display			
Backlight	LED		
Display Area	56.22 in x 31.61 in/ 1428 x 803mm	64.96 in x 36.54 in/ 1650 x 928mm	74.61 in x 41.97 in/ 1895 x 1066mm
Display Ratio	16:9		
Resolution	3840 x 2160 Pixel		
Display Colors	10 bit + FRC, 1.07 billioncolors	10 bit + FRC, 1.07 billioncolors	10 bit, 1.07 billion colors
Brightness	≥ 450 cd/m ² for (65" & 75") & ≥ 500 cd/m ² for 86"		
Contrast	15000:1		
Response Time	Typ. 4ms		
Life Time	≥ 50000 h (Min.)		
Speaker			
Speaker Position	Bottom		
Max. Power Output	Full Amplifier 2 x 20 W		
Microphone			
Type	3.5 mm interface		
Electrical			
Power Consumption	Maximum ≤ 400 W Standby Mode ≤ 0.5 W	Maximum ≤ 450 W Standby Mode ≤ 0.5 W	Maximum ≤ 500 W Standby Mode ≤ 0.5 W
Working Voltage	AC100-240V Max 6.0A		

Model	65inch	75inch	86inch
Touch			
Touch Surface	Anti-Glare, Anti-Fingerprint, Antimicrobial Tempered Glass		
Transparency	88%±3%		
Touch Points	Windows 40 Points Android 20 Points (Max.)		
Writing Tools	Eraser, Stylus or Finger		
Scan Speed	≤4ms		
Communication Interface	USB-A		
Transportation/Storage			
Storage Temperature/ Humidity	-20~60°C/0~90%RH (Non-condensing)		
Working Temperature/ Humidity	0°C-40°C/20~80%RH(Non-condensing)		
Mounting (optional)	Wall-mounted/Mobile Stand		
Outline Dimension	1513x926x116mm	1735x1050x116mm	1981x1190x116mm
Packing Dimension	1640x1036x207mm	1859x1160x227mm	2119x1290x275mm
Ports			
Front Interface Inputs	HDMI In x 1, USB (Touch) x 1, USB 3.0 x 2, Microphone In x 1, Type C x 1		
Rear Interface Inputs	USB2.0 (Touch) x 1, HDMI 1/2 In x 2, DP x 1, USB 2.0 (Public) x 2, USB 2.0 (Android) x 1, RS-232 x 1, Earphone x 1, SPDIF out x 1, HDMI Out x 1, Audio-VGA x 1, VGA x 1, Battery Slot x 1, OPS Slot x 1 (4K@60Hz), Wi-Fi Module Slot.		
Other functions			
Intelligent thermos protector	Yes		
Smart System			
Android	Android Version 11		
RAM	Standard with 4G		
Flash	64GB (Onboard 32GB + SD Card 32GB)		

Model	65inch	75inch	86inch
Multimedia File Formats	Supports all major types of multi-media files		
Pre-installed applications	Refer to the actual panel display.		
Wi-Fi Module			
Parameters	Wi-Fi 6 + BT 5.2		

For More Information

Please visit our website (<https://newlineinteractive.in/>) for detailed instruction manual.

Contact Us for Support

Please email us at info.in@newline-interactive.com

Our company is devoted to product innovation and technology enhancement. Therefore, we may change product specification and information without notice. Product pictures in the manual are for reference only, please refer to actual products.